



扫描二维码
获取电子说明书
www.emotobykes.com



Ultra Bee Series Electric Motorcycles Owner's Manual

Manufacturer: CHONGQING QIULONG TECHNOLOGY
CO., LTD

Address: NO. 29, NO. 2 ZHICAI VILLAGE, QIEZIXI
STREET, DADUKOU DISTRICT, CHONGQING, CHINA

Post Code: 400082 Tel:023-68905603

Version: YQ5A-EN-V1.0 Issue Date: 2023.01.13

This manual will provide you a better understanding of your Ultra Bee electric motorcycle. Please take your time to read this manual and all safety labels carefully before riding.

This manual contains the most current product information available at the time of printing, your motorcycle may look and setup differ from the information supplied in this owner's manual. Please visit our website www.sur-ron.com for updates and additional information about your motorcycle.

This manual covers the following electric motorcycles:



Ultra Bee R (Road)

ABS
Headlight, Turn Signals
and Rear Brake Light
AT Tires



Ultra Bee T (Trail)

Headlight, Turn Signals
and Rear Brake Light
Offroad Tires



Ultra Bee X
Version (Offroad)

ABS
Headlight, Turn Signals
and Rear Brake Light
Offroad Tires

Riding tips for maximum range

Range varies in Ultra Bee electric motorcycles similarly to how it varies in gas motorcycles. The range variety of Ultra Bee electric motorcycles comes from the riding application after each full charge. In addition to riding habits, energy consumption is also affected by environmental conditions (such as extreme cold or hot weather, riding on steep hill or soft sand etc.). To achieve the maximum range with a single full charge, please pay attention to reduce the maximum speed, less sudden acceleration and maintain a constant speed to ensure the maximum range.

To reach the maximum range, please following the tips below:

1. Avoid frequent and acute acceleration and braking.
2. Under absolute safe riding conditions, please reduce the riding speed by using the throttle to decelerate instead of pulling the brake lever. When you're riding the Ultra Bee, if the motorcycle is moving and the throttle is in the idle position, the energy regenerative brake will reduce the speed of the Ultra Bee and converting the kinetic energy to charge the battery pack.
3. Maintain a correct tire pressure (Please refer to Recommended tire pressure table at page 10.9).
4. Remove unnecessary goods and reduce load.
5. The maximum range in winter or summer could be slightly different.

In conclusion, you can estimate your range according to the above factors and your riding habits.

Note: The range will be varying significantly according to the various tough road conditions during offroad riding.

介绍.....	1.1
重要信息.....	1.1
运输方式.....	1.2
安全信息.....	2.1
安全驾驶要求.....	2.1
重要信息.....	2.2
重要标签的位置.....	2.4
功能简介.....	3.1
显示与指示.....	4.1
仪表介绍.....	4.1
功能设置.....	5.1
仪表设置.....	5.1
系统功能设置.....	5.3



功能介绍.....	6.1
车把控件.....	6.1
动力模式开关.....	6.4
驻车制动操作.....	6.4
电池组的拆卸.....	6.5
电池组的安装.....	6.6
充电器的存放.....	6.7
启动和运行.....	7.1
骑乘前检查.....	7.1
电控锁.....	7.2
方向锁.....	7.2
座垫锁.....	7.3
驾驶极蜂电动摩托车.....	7.3
温度指示器.....	7.4
ABS（防抱死制动系统）.....	7.5
前减震调节.....	7.7
后减震调节.....	7.8



电源管理.....	8.1
电池组.....	8.1
电源和充电.....	8.2
动力系统管理.....	9.1
动力系统.....	9.1
保养和维护.....	10.1
保养和维护项目.....	10.1
维护记录.....	10.1
定期维护.....	10.1
维护计划.....	10.1
关键紧固件力矩管理.....	10.3
电池组.....	10.5
制动系统.....	10.5
减震系统.....	10.8
车轮和轮胎.....	10.9

链条.....	10.9
前照灯调整.....	10.11
灯具更换.....	10.12
车辆清洗.....	10.12
长期存放车辆.....	10.13
极蜂电动摩托车配件.....	10.14
保险丝.....	10.14
整车电气原理图.....	10.15
故障排除.....	11.1
极蜂电动摩托车故障排除.....	11.1
冷热天气注意事项.....	11.1
安全联锁.....	11.2
极蜂电动摩托车注意事项.....	11.2
系统警告信息.....	11.3
常规故障排除.....	11.7

保修与售后信息.....	12.1
有限保修条件.....	12.1
虬龙科技销售车辆的保修期.....	12.1
保修涵盖的零件.....	12.2
保修工时.....	12.2
有限保修的限制.....	12.2
车辆所有者责任.....	12.3
保修限制.....	12.3
如何获得保修服务.....	12.4
附表.....	13.1
维护记录表.....	13.1
售后记录表.....	13.7
车型参数对比表.....	13.9
国内经销商.....	13.11

Important notice ///

Congratulations on your decision to purchase a Surron electric motorcycle.

We welcome you to the community of Surron motorcycle riders. you are now the owner of state-of the art electric motorcycle which, with appropriate care, will bring you pleasure for a long time to come.

This electric motorcycle has been designed and built mainly to withstand the normal stresses and strains of offroad use. This electric motorcycle is only authorized for operation on public roads in its homologated version. This motorcycle must only be used as intended, dangers can be arisen for people, property and the environment through use not as intended.

This manual is designed to provide you with a better understanding of the operation, inspection, basic maintenance requirements, main functions, helpful tips and explain important safety matters of this electric motorcycle. Please read through this Owner's manual carefully, exercise caution when using the motorcycle, and contact Surron or authorized Surron dealer if you have any questions. For latest manual updates and additional information about your motorcycle, visit Surron website:

/// www.sur-ron.com ///

This manual is intended for personal use only, this manual is not intended for commercial use. To protect your investment, we urge you to take responsibility for keeping your Ultra Bee well maintained. Scheduled service is a must, of course. But it's just as important to observe the break-in guidelines, and perform all the pre-ride and other periodic checks detailed in this manual. This Owner's Manual should be considered a permanent part of this motorcycle and should remain with it even if the motorcycle is subsequently sold. Please make sure the next owner well received the manual, it is, by law in some country or region, an important part of the vehicle.

All specifications contained herein are non-binding. This manual contains the word WARNING to indicate something that could hurt you or others. The terms "right" or "left" in this manual refer to the rider's right or left when sitting on the motorcycle.

If you have any questions concerning the operation or maintenance of your motorcycle, or if you ever need a special service or repairs, please contact your authorized Surron Motorcycles dealer, remember that your dealer knows your Ultra Bee best and is dedicated to your complete satisfaction. If the dealer's service not met your requirement, you can also contact Surron After-sale Service Department for help at any time:

/// service@qiulongtech.com ///

Happy riding! We wish you good and safe riding at all times.

WARNING

If the power supply, charging system or any other power related equipment is damaged or malfunctioned, please stop using the charger or vehicle immediately and contact the local Surron authorized dealer or workshop for replacement or repair.

WARNING

This product can expose you to chemicals, including lead and BPA, which are known to the State of California to cause cancer or birth defects or other reproductive harm. For more information, go to www.p65Warnings.ca.gov.

Transporting ///

It is highly recommended that the electric motorcycle be firmly secured on the transport frame using ratchet straps while it is being transported. It is recommended that the soft straps must be used to reduces scratches or other damages.

It is recommended to fix the ratchet straps according to the points shown in the figure. The front two are tied to the handlebar and the back two are tied to the left and right swing arm. Please do not damage the chain or brake line when tied the straps. The tie down straps should be at a 45° angle from the motorcycle. Follow the manufactures instructions for the ratchet straps you are using.

If you use a truck or motorcycle trailer to transport your Ultra Bee, we recommend that you follow these guidelines:

1. Use a loading ramp.
2. Secure the motorcycle in an upright position, using motorcycle tie-down straps. Avoid using rope, which can loosen and allow the motorcycle to fall over.

To secure your Ultra Bee, brace the front wheel against the front of the truck bed or trailer rail.

Attach the lower ends of two straps to the tie-down hooks on truck bed or trailer rail. Attach the upper ends of the straps to the handlebar (one on the right side, the other on the left), close to the fork.

Check that the tie-down straps do not contact any control cables or electrical wiring.

Safety Information

Tighten both straps until the front suspension is compressed about half-way. Too much pressure is unnecessary and could damage the fork seals.

Use another tie-down strap to keep the rear of the motorcycle from moving.

We recommend that you do not transport your Ultra Bee on its side. This can damage the motorcycle.



2.1

Safety Riding Requirement

Your electric motorcycle can provide many years of service and pleasure if you take responsibility for your own safety and understand the challenges you can meet while riding. There is a lot you can do to protect yourself whilst riding. Be aware that offroad racing is a physically demanding sport that requires more than just a fine motorcycle. To do well, you must be in excellent physical condition and be a skillful rider. For the best results, work diligently on your physical conditioning and practice frequently.

This electric motorcycle has been designed and built mainly to withstand the normal stresses and strains of offroad use. This electric motorcycle is only authorized for operation on public roads in its homologated version. This motorcycle must only be used as intended, dangers can be arisen for people, property and the environment through use not as intended.

You will find many helpful recommendations, safety instructions throughout this manual. The following are a few that we consider to be most important.

Ultra Bee is a high performance electric motorcycle and should be treated with extreme caution.

Proper safety gear, including a regional/national approved helmet, riding boots, eyewear, gloves, and protective clothing should be worn while riding to reduce the risk of potential injury, whether you are practicing to improve your skills, or riding in competition. We highly recommend the use of full

Safety Information

height motocross boots since the vast majority of motorcycle injuries are through ankle, leg and foot impact.

Read all warnings and instructions in this manual as well as all the safety labels before operating your electric motorcycle.

Never allow a guest to ride your electric motorcycle without proper instruction.

Ensure you have the legal qualification to ride the motorcycle before operation.

Never consume alcohol or drugs before operation of your electric motorcycle. Even one drink or drug can reduce your ability to respond to changing conditions, and your reaction time get worse with every additional drink or drug. So don't consume alcohol or drugs and ride, and don't let your friends or others drink and ride either.

People unwilling or unable to take responsibility for their actions should not use this motorcycle. You assume all responsibility while operating your motorcycle. The seller assumes no liability for misuse or operator negligence.

Take time to get to know your Ultra Bee. Because every motorcycle is unique, take time to become thoroughly familiar with how this one operates and responds to your commands before placing your machine, and yourself, in competition.

Learn and respect your limits. Never ride beyond your

personal abilities or faster than conditions warrant. Remember that alcohol, drugs, illness and fatigue can reduce your ability to perform well and ride safely.

Keep your Ultra Bee in safe condition. Use only Surrón approved parts and Surrón Motorcycles accessories. Maintaining your Ultra Bee properly is critical to your safety. A loose bolt, for example, can cause a breakdown in which you can be seriously injured. Only operate the vehicle when it is in perfect technical condition, in accordance with its intended use, and in a safe and environmentally compatible manner.

This motorcycle is a high voltage electric motorcycle, follow the safety and caution instruction that apply when using an electric motor. If you smell an unusual odor coming from the lithium-ion (Li-Ion) battery, park your Ultra Bee in a safe place outside and away from flammable objects, then turn off the key switch. Contact your local Surrón authorized dealer to help you to inspect your Ultra Bee immediately.

Prior to each use, the rider must check everything in the "Check before Riding" section on page 7.1, and the charge level of the battery pack as indicated on the dashboard display.

It is important to keep your motorcycle properly maintained and in safe riding condition. Having a breakdown can be difficult, especially if you are stranded offroad far from your base. To help avoid problems, inspect your motorcycle before every ride

2.2

Safety Information

and perform all recommended maintenance according to the maintenance schedule and adjustment requirements listed in this manual. Be sure you understand the importance of checking all items thoroughly before riding. If you are the Ultra Bee offroad version owner, please understand your motorcycle is designed and manufactured for offroad use only. The tires are not made for paved surface use and the motorcycle does not have turn signals or other features required for use on public roads. If you need to cross a paved or public road, use other authorized vehicle to transporting or get off the motorcycle and push your motorcycle to your destination.

2.3

The rear brake lever is located on the left side of the handlebar. Because this electric motorcycle does not have a manual transmission, there is no clutch and gear shifting.

Modifying the motorcycle is prohibited, as otherwise safe operation cannot be guaranteed. modified such as using opening Li-ion battery or motor etc., may render the motorcycle unsafe and may cause severe personal injury. The manufacturer cannot be held liable for non-approved modifications.

Be very careful when loading or adding accessories to your motorcycle. Large or heavy items may adversely affect the handling and performance of your motorcycle.

Safety Information

Important Information

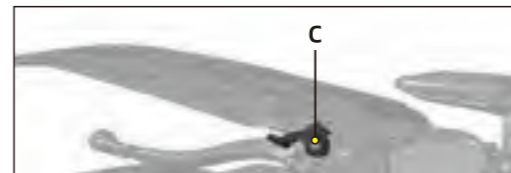
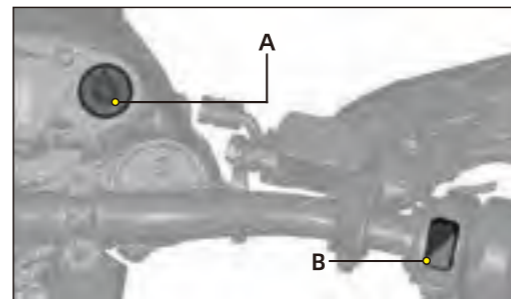

Several important operation considerations are listed below:

Always turn the key switch A and motor stop switch B to the OFF position when not actively riding. It is extremely easy to forget that the motorcycle is still in standby mode because it is completely silent. An accident might occur if the motorcycle is left powered up while getting on or off the motorcycle.

Turn the motor stop switch B OFF and make sure the READY indicator is not light up when pushing or moving the motorcycle.

Use the parking brake C when you are stopped on a ramp or steep hill. Do not hold partial throttle to keep the motorcycle stationary on a ramp or steep hill, it can trigger the locked rotor protection which cause the motorcycle to slip back.

A rechargeable Lithium-ion battery are installed in the motorcycle. The battery pack are located under the seat, please recharge the battery pack of your electric motorcycle after each use. Once fully charged, disconnect from AC power supply. Make sure that the charging is carried out in a safe and open space or with monitoring.

When unplugged the battery power plug while the key in the OFF position, the motorcycles electronic components will consume a small amount of power and the battery pack will drain extremely slowly. If you don't ride for a long-term period of time (30 days or more), you may need to charge the electric motorcycle for a few hours prior to your next ride.

The battery pack will be damaged if it is stored for a long time under low power.

2.4

Safety Information

CAUTION

Only charge the Ultra Bee lithium-ion battery pack with the motorcycle's original charger or the Surron approved charger. Only use the battery pack while it is inside the vehicle.

The battery pack does not require nor benefit from deep discharging. To get the most battery pack lifecycle, recharge the battery pack after each ride. Constantly leaving the battery pack in a deep discharging state will damage the battery cell.

Failure to follow instructions of battery pack storage and charging as written in this manual may void the warranty of your Ultra Bee electric motorcycle. These guidelines have been rigorously tested to ensure maximum battery pack efficiency and service.

Note

The battery pack contains components and elements that might harmful the environment, please dispose the battery pack properly and in compliance with the applicable regulations. Never throw the battery into the household trash bin.

2.4

Location of Important Labels //

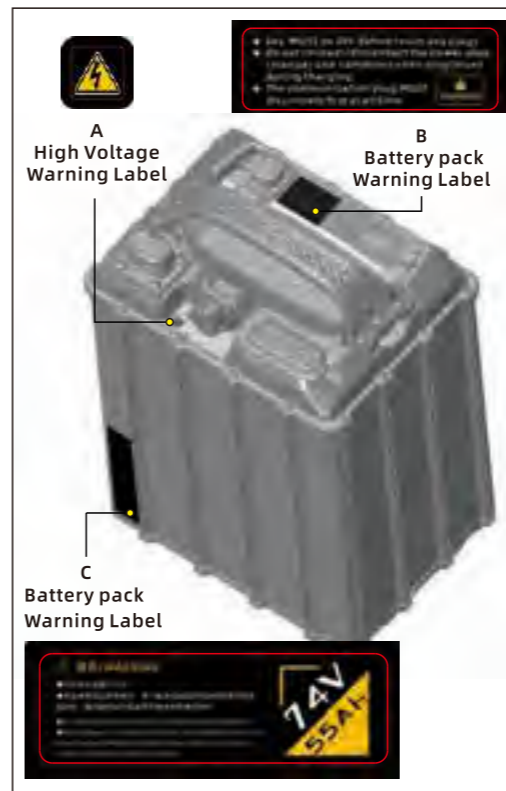

Safety Information

MCU recommended torque label A, MCU info label B

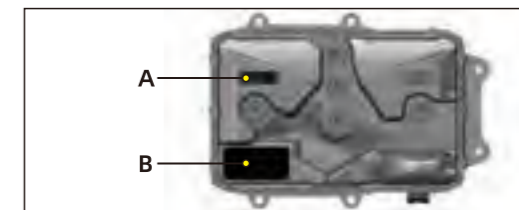

Frame Nameplate A, VIN label B



Motor Serial Number A

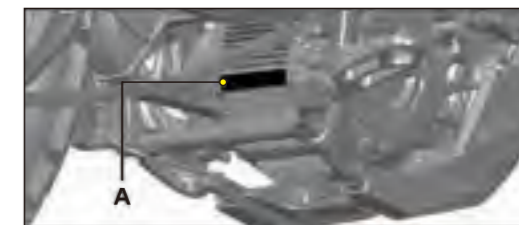

2.5

T-BOX(Telematics BOX)
S/N Label



Vehicle VIN Label

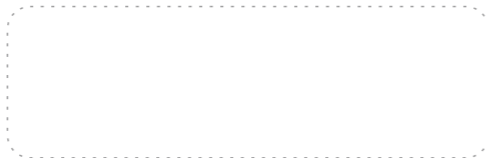

T-BOX(Telematics BOX)
SIM Label

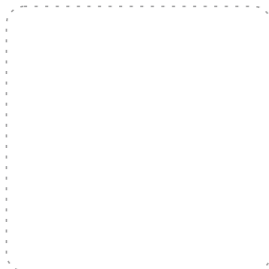

If your vehicle has T-box installed, please visit the
Download Center of Surron official website.
Download the Surron App, install and link the device to use.



Scan this QR
code to enter
the Download
Center.

2.6



Feature Introduction

3.1

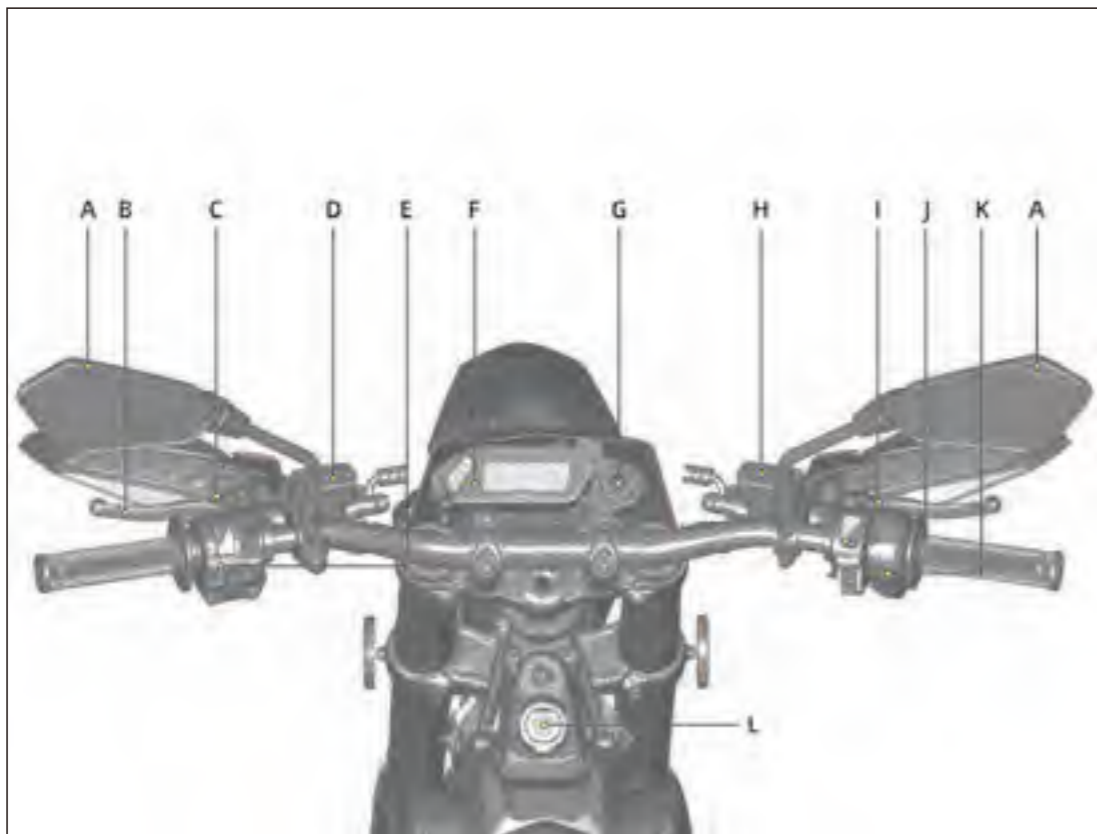

-FETCH LIGHT-飞起来-

Feature Introduction

3.2

A. Mirrors

This Ultra Bee electric motorcycle is equipped with convex mirrors. A convex mirror has a curved surface. Convex mirrors offer a greater field of view than a similar flat mirror. However, the greater field of view makes objects seem further away than they really are. Care must be taken when judging the distance of objects seen in these mirrors.

B. Rear Brake Lever

For description and operation, please refer to "Feature Introduction" , on page 6.1.

C. Parking Brake Lever

For description and operation, please refer to "Feature Introduction" , on page 6.1

D. Rear Brake Fluid Reservoir

For description and operation, please refer to "Maintenance" , on page 10.5.

E. Left Combination Switch

For description and operation, please refer to "Feature Introduction" , on page 6.1.

F. Dashboard

For description and operation, please refer to "Display and Indicator" , on page 4.1. and "Feature Setting" , on page 5.1.

G. Key Switch

For description and operation, please refer to "Starting and Operating" , on page 7.2.

H. Front Brake Fluid Reservoir

For description and operation, please refer to "Maintenance" , on page 10.5.

I. Front Brake Lever

For description and operation, please refer to "Feature Introduction" , on page 6.3.

J. Right Combination Switch

For description and operation, please refer to "Feature Introduction" , on page 6.3.

K. Throttle Grip

For description and operation, please refer to "Feature Introduction" , on page 6.3.

L. USB Port

5V 2.4A USB A port

-FETCH LIGHT-飞起来-

Feature Introduction

3.3

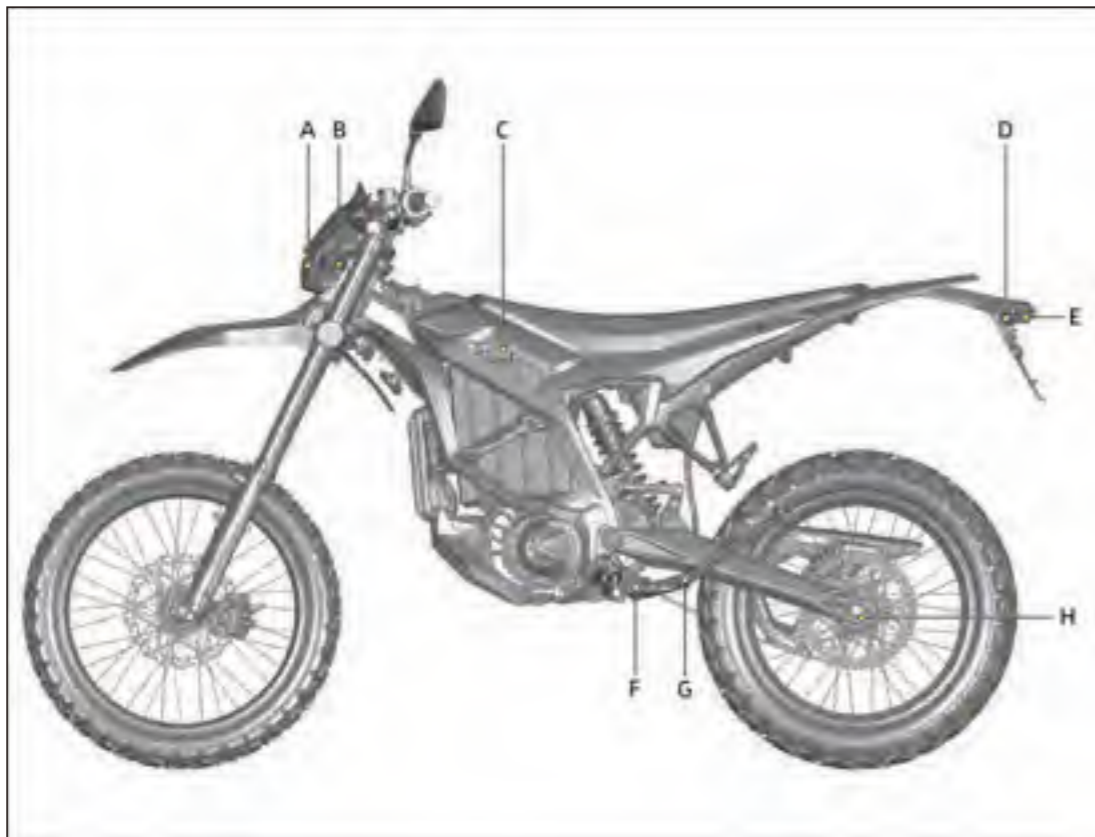

-FETCH LIGHT-飞起来-

A. Headlight

For headlight operation, please refer to “Feature Introduction” , on page 6.1.

For headlight replacement, please refer to “Maintenance” , on page 10.12.

For headlight alignment, please refer to “Maintenance” , on page 10.10.

B. Front Turn Signals

For turn signals operation, please refer to “Feature Introduction” , on page 6.1.

For turn signals replacement, please refer to “Maintenance” , on page 10.12.

C. Integrated Battery Charging Port

For description and operation, please refer to “Power Management” , on page 8.1.

D. Rear Turn Signals

For rear turn signals operation, please refer to “Feature Introduction” , on page 6.1.

For rear turn signals replacement, please refer to “Maintenance” , on page 10.12.

Feature Introduction

3.4

E. Brake/Tail/License Plate Light

For brake/tail/license plate light replacement, please refer to “Maintenance” , on page 10.12.

F. Side Stand Switch

This switch is a safety sensor that prevents accidentally incorrect motorcycle operation when the side stand is down.

G. Side Stand

The side stand supports the motorcycle when parked. The key switch should be in the OFF position when parked.

H. Chain Adjuster

Located on left and right side of the swingarm, for the tension adjustment procedure. please refer to “Maintenance” , on page 10.9.

CAUTION

Park the motorcycle only on a flat firm surface, otherwise the motorcycle could fall over and causing damage.

-FETCH LIGHT-飞起来-

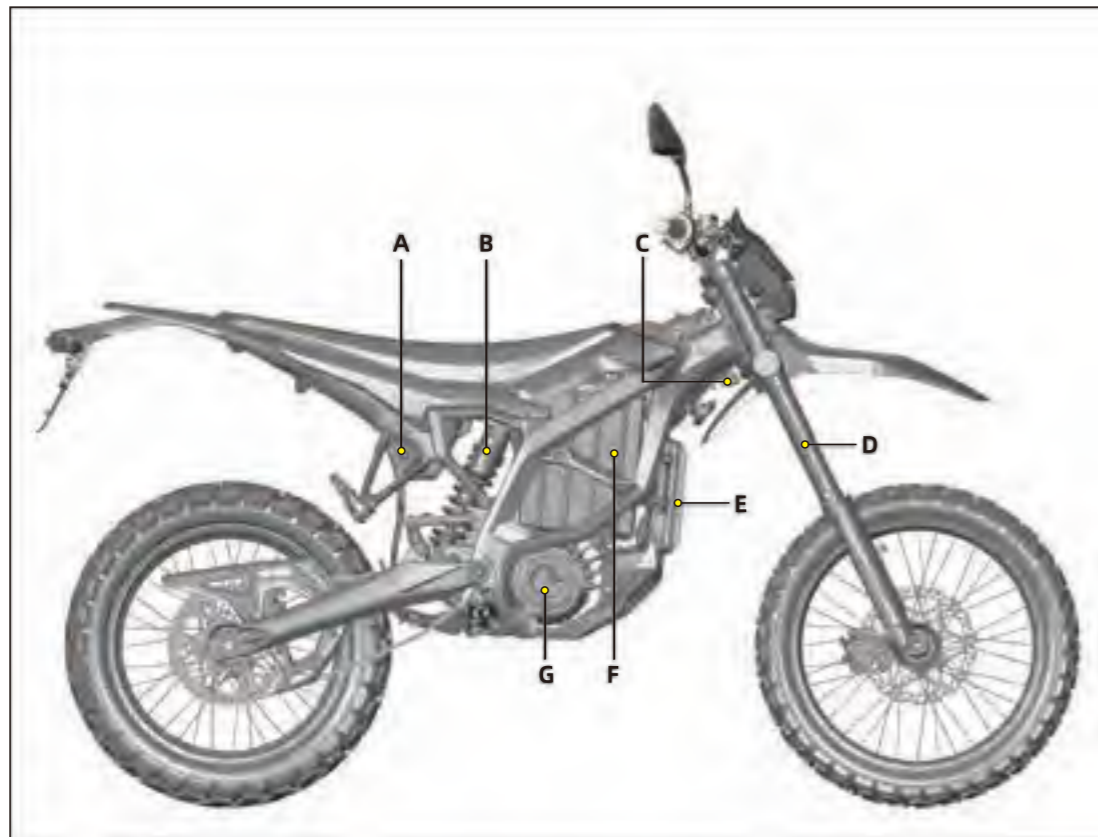

A. Seat Lock

For description and operation, please refer to "Starting and Operating" , on page 7.3.

B. Rear Shock Absorber

For description and operation, please refer to "Starting and Operating" , on page 7.8.

C. Steering Lock

For description and operation, please refer to "Starting and Operating" , on page 7.2.

D. Front Fork

For description and operation, please refer to "Starting and Operating" , on page 7.7.

E. MCU

For description and operation, please refer to "Power System Management" , on page 9.1.

F. Battery Pack

For description and operation, please refer to "Power Management" , on page 8.1.

G. Motor

For description and operation, please refer to "Power System Management" , on page 9.1.

Display and Indicator

Dashboard Overview

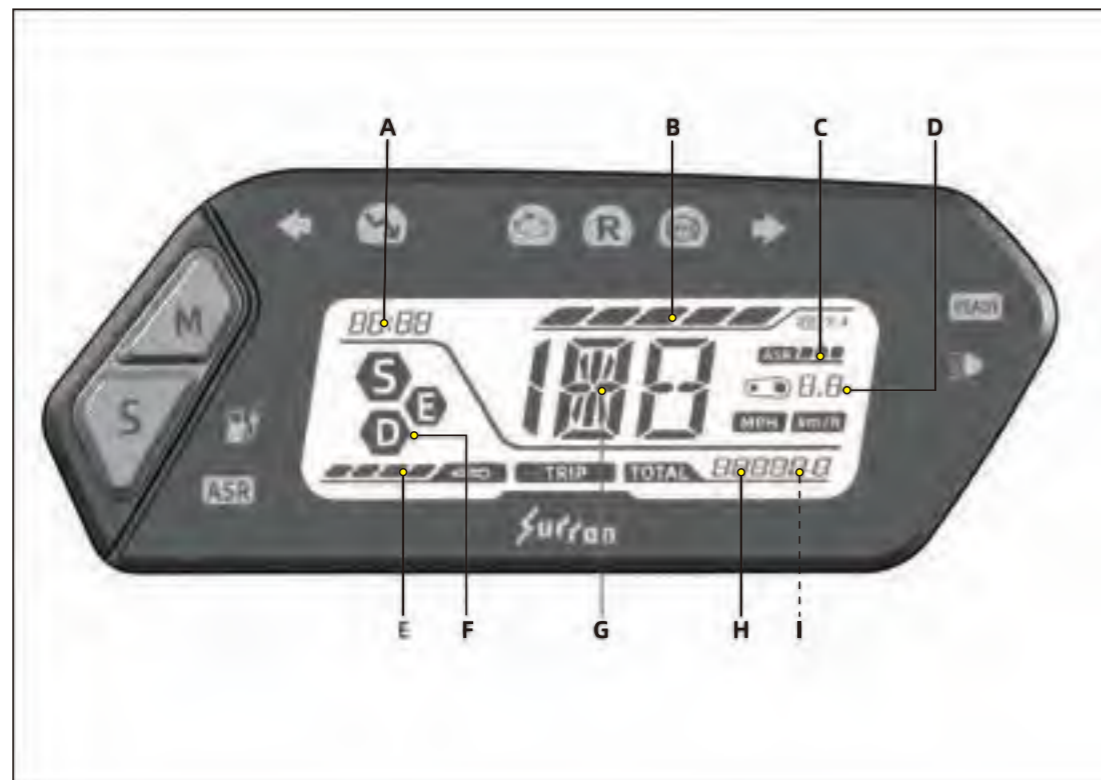

4.1

Display and Indicator

A. Clock

The clock displays time in 24-hour mode.

B. Charge Indicator

This indicator and readout display the amount of energy remaining in the battery pack similar to the fuel gauge on a gasoline powered motorcycle.

C. ASR Indicator

This indicator displays the current ASR (Traction Control) level, disappear when ASR is turned OFF.

D. Transmission Ratio Display

It displays the current transmission ratio of Ultra Bee electric motorcycle.

E. Temperature Indicator

The temperature indicator is on the left side of the dashboard LCD display, indicating the overall temperature of the motor, MCU and battery pack. When the temperature of one of these components exceeds the maximum temperature limitation, the temperature indicator will start to flash. For description and operation, please refer to "Starting and Operating", on page 7.4.

F. Riding Mode

This area displays the riding mode (S, E, D) corresponding to the Riding mode of SPORT, ECO and DAILY. The Riding mode switch is located on the right

handlebar.

For description and operation, please refer to "Feature Introduction", on page 6.4.

G. Speedometer

The speedometer is digital display either kilometers per hour (km/h) or miles per hour (mph).

For description and operation, please refer to "Feature Setting", on page 5.1.

H. Odometer

The odometer displays the total distance the motorcycle has been ridden in kilometers or miles.

I. Warning Code Display

When the system fault has been detected, the corresponding Warning Code will be displayed on this area. For Warning Code explanation, please refer to "Troubleshooting" on page 11.4.

4.2

Display and Indicator

A. Left Turn Signals Indicator

Once the Left Turn Signals switch is toggled, the Left Turn signals remains flashing until the Turn signals request has been canceled.



B. Low Power Indicator

This indicator displays the condition of the power system, remain flashing when power system enter low power mode.



C. System Warning Indicator

The indicator illuminates when a fault has been detected. Please refer to "Troubleshooting" for detailed Warning Code, on page 11.4.



D. Reverse Mode Indicator (R)

The indicator illuminates when reverse mode is ready to use; the indicator flash when the reverse mode is in use; the indicator disappears when the reverse mode is OFF.



E. ABS (Anti-Lock Brake System) Indicator

The indicator illuminates or flashes when ABS system fault has been detected or it is been turned OFF. For description and operation, please refer to "Starting and Operating" , on page 7.5.



F. Right Turn Signals Indicator

Once the Right Turn Signals switch is toggled, the Right Turn signals remains flashing until the Turn signals request has been canceled.



G. Low Energy/Charging Indicator

When the energy remaining in the battery pack is low (State of Charge (SOC) < 20%), the low energy indicator illuminates. If the energy remaining in the battery pack is very low (SOC < 5%), the indicator flashing. The



Display and Indicator

indicator also flashing when the motorcycle is charging.

H. ASR (Traction Control System) Indicator

The ASR (Acceleration Slip Regulation) traction control feature is turned ON and OFF by the ASR button, and the ASR indicator illuminates when activate and goes off if ASR has been turned OFF. When the ASR indicator flashes means the speed sensor or the ASR feature is malfunctioned. Please check whether the gap between the wheel speed sensor and the speed sensor ring is in the range of 0.8 ~ 1.2mm, and whether the wheel speed sensor is damaged.



I. Ready Indicator

The indicator illuminates mean the motorcycle is ready to go, twist the throttle when the indicator illuminated, the motorcycle will move.



J. High Beam Indicator

When the headlight high beam is ON, this indicator illuminates.

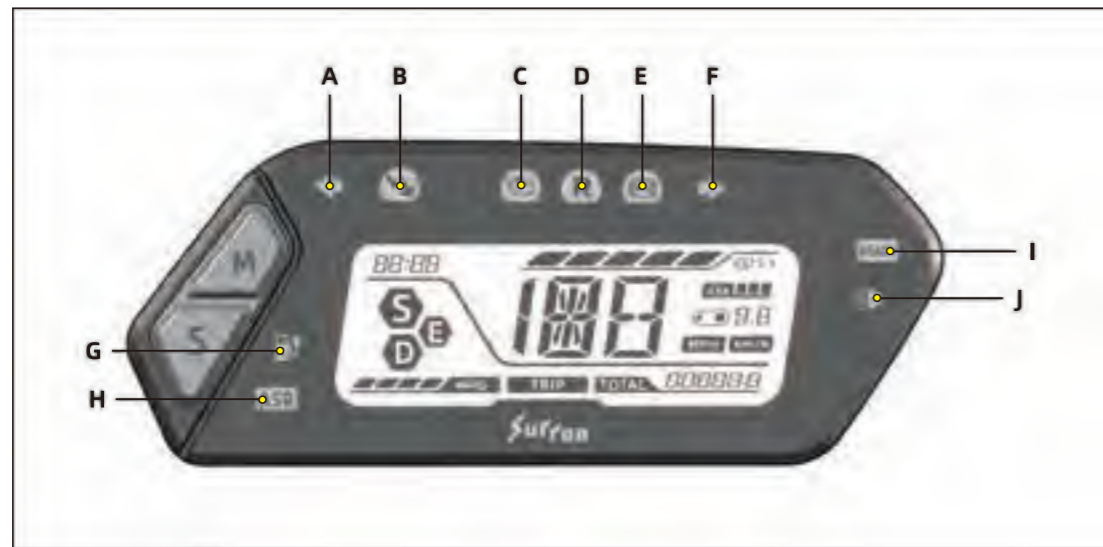

Feature Setting



Dashboard Setting

5.1

The features and displays on the dashboard can be customized to your personal preferences by using the A and B buttons on the Handlebar Control.

A. Mode Button (M)

By momentarily pressing or holding the M button you can reset fields and toggle through the menus and display options.

B. Select Button (S)

To select the corresponding feature by pressing S button when entered the feature menu.

Display - Odometer



Select total or trip mileage:

1. To select the display of total **TOTAL** or trip mileage **TRIP**, momentarily press the M button when the dashboard in main display mode and the speed of the motorcycle is 0km/h.

2. When Trip mileage displayed, and the motorcycle speed is 0km/h, the speedometer display area shows the Top speed; the speedometer will instantly display the current speed when the motorcycle starts to moving.

Reset trip mileage and maximum speed:

To reset the trip mileage and maximum speed, simultaneously by pressing and holding the S button for more than 2 seconds in the trip mileage mode, when the dashboard in main display mode and the speed of the motorcycle is 0km/h.



Unit Display - Speed

Select Miles per Hour (MPH) or Kilometer per Hour (km/h) :

1. When the motorcycle key switch is in OFF, press and hold the M button and turn the key switch ON whilst still holding the M button for more than 2 seconds, then select between Miles per Hour (MPH) and Kilometer per Hour (km/h).

2. **MPH** is displayed when Miles per Hour (MPH) has

been selected.

3. **km/h** is displayed when Kilometer per Hour (km/h) has been selected.

Display - Transmission ratio

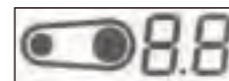

Transmission ratio setting:

When the motorcycle key switch is in OFF, press and hold the S button and turn the key switch ON whilst still holding the S button for more than 2 seconds, then enter into the transmission ratio setting mode, and “**8.8**” indicator flashes. To adjust the transmission ratio by momentarily press M button or S button. Momentarily press S button to decrease transmission ratio by 0.1 till lowest transmission ratio; Momentarily press M button to increase by 0.1 till highest transmission ratio. Press and hold M button for more than 2 seconds to save the current setting (automatically save and exit transmission ratio setting mode after no action for 5 seconds).

Attention

When the speed display on the speedometer is higher than the actual speed, reduced the transmission ratio until meet the actual speed; increase transmission ratio if speed display on the speedometer is less than the actual speed.

Feature Setting

Caution:Please change the transmission ratio with cautious. (Stock original transmission ratio is 1.0).

Time Display

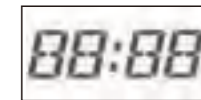

Clock Setting:

Press and hold the M button for more than 2 seconds after the motorcycle is switched ON, speed is 0km/h to enter the clock setting mode, the “Hours” will start to flash and ready to adjust; momentarily press M button again, the “Minutes” will start to flash and ready to adjust; momentarily press M one more time will quit clock setting mode.

When “Hours” is flashing and ready to be set, momentarily press S button will increase 1 hour, press and hold S button increase will increase “Hours” gradually until release S button. After finished the “Hours” adjustment, momentarily press M button will save current setting and enter “Minutes” setting.

When “Minutes” is flashing and ready to be set, momentarily press S button will increase 1 minute, press and hold S button increase will increase “Minutes” gradually until release S button. After finished the “Minutes” adjustment, momentarily press M button will save current setting and quit clock setting mode.

5.2

Feature Setting

ASR (Traction Control System) Indicator



When you use the ASR button to turn the ASR ON and OFF or select the ASR setting level, the ASR level will display as follow:

ASR Display Explanation	
	non display(ASR turned OFF)
	display(ASR turned ON level1)
	display(ASR turned ON level2)
	display(ASR turned ON level3)

For description and operation, please refer to "Feature Introduction", on page 6.2.

5.3

System Feature Mode Display

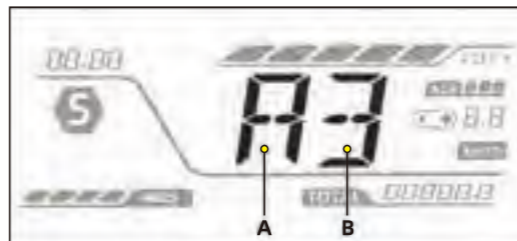

Note: Display one English letter in field A (Different English letters are displayed according to different feature modes). Display one number in field B (Different Numbers are displayed according to different feature modes).

System Feature Mode Setting:

When the motorcycle in its normal operating mode or with side stand down, press and hold ASR button in Left Combination Switch and Ready button in the Right Combination Switch at the same time over 2 seconds to enter the system feature setting mode. After enter the system feature setting mode: Momentarily press ASR button in Left Combination Switch to switch between each feature, such as B2, E3, P0, etc. For example, when feature B2 shown on the dashboard, momentarily press Ready

Feature Setting

button in Right Combination Switch to switch between different setting levels, such as B3, B4, B0, B1, etc. Switch in sequence until find the correct setting level. If there is no action for a long time, system will exit automatically.

The available features are listed below:

1. Level setting for brake energy regenerative feature (B0 B1 B2 B3 B4 B5) Factory default at B2 (feature is disabled in B0, and strengthens in turn from B1 to B5).
2. Level setting for coast energy regenerative feature (E0 E1 E2 E3 E4 E5) Factory default at E3 (feature is disabled in E0, and strengthens in turn from E1 to E5).
3. Level setting for ASR feature (A1 A2 A3) Factory default at A2 (feature strengthens in turn from A1 to A3).
4. Setting for brake override feature (P0 P1) Factory default at P0 (feature is disabled in P0, and activated in P1).
5. Setting for tilt protection feature (C0 C1) Factory default at C1 (feature is disabled in C0, and activated in C1).
6. Diagnostic report feature (T0 T1) Factory default at T0 (feature is disabled in T0, and activated in T1).
7. Throttle sensitivity adjustment feature (F1 F2 F3) Factory default at F1 (feature sensitivity is strengthens in turn from F1 to F3, ONLY available in

SPORT mode).

8. Charging power adjustment feature (U1 U2 U3) Factory default at U3 (U1 means the charging power is 480W; U2 is 750W; Maximum charging power U3 is 1100W).

Exit System Feature Mode Setting (X):

1. Make sure the Key Switch is ON and lift the side stand will exit System Feature Mode Setting
2. If no action in 10 seconds, it will exit System Feature Mode Setting automatically.

Warning

It is recommended to turn off the tilt protection in off road environment, to avoid the loss of power due to the triggering of tilt protection when performing some jump or stunt. To extend the life span and the safety of the battery pack, when battery state of charge (SOC) is over 95% or battery internal temperature exceed the working condition temperature between 0°C to 50°C, the energy regenerative system will be disabled.

5.4

Feature Introduction

Handlebar Controls

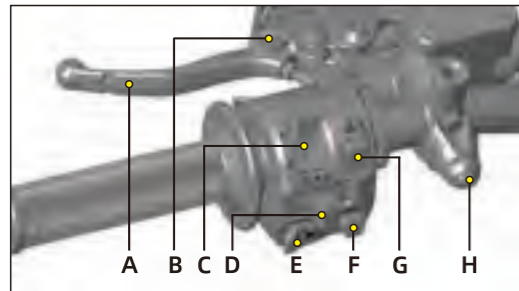

6.1

A. Rear Brake Lever

When you pull or squeeze the brake lever, it will control the rear brake system. When braking, the throttle should be in the idle position. The brake lights are also lit.

B. Parking Brake

When parking on a steep hill or ramp, apply the parking brake to prevent the motorcycle from rolling back. For instructions and operations, please refer to page 6.4 of "Feature Introduction".

C. Headlight High/Low Beam Switch

When the switch is pressed, the headlight changes from low beam to high beam. It remains in the selected position until it is switched back. When in the high beam position, the high beam indicator on the dashboard lights up.

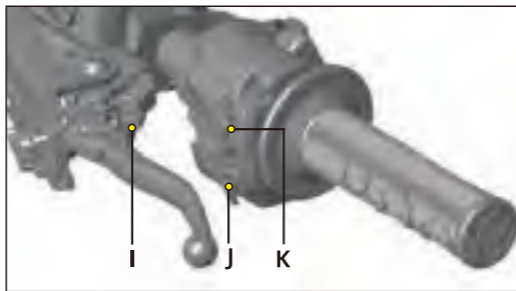

D. Turn Signals Switch

When you push the Turn signals switch to the left or right, the corresponding front and rear Turn Signals will flash. When the Turn signals light switch is turned on, the Turn signals indicator on the dashboard light up.

Be sure to turn and change lane operations in accordance with the local law and regulations. Unlike cars or other vehicle, Turn Signals can only be manually canceled on the Ultra Bee motorcycle. Press the switch and it will return to the OFF (middle) position.

E. Horn Button

When the Key switch is in the ON position, the horn will operate when the button is pressed. The Ultra Bee motorcycle is very quiet when riding, and the horn can be used to warn pedestrians, cyclist, driver or any other personal present.

Feature Introduction

6.2

F. R/S Button (Reverse Mode\ASR quick setting)

Reverse mode: When the throttle is in fully closed position, press and hold the R/S button, the reverse indicator R on the dashboard will illuminate, and the Ultra Bee motorcycle will enter the Reverse mode.

Only when the R/S button is released and the throttle is returned to fully closed position, the system will exit the reverse mode and the forward mode will be functionally again.

The Ultra Bee motorcycle will "shake" to remind the rider when enter or exit Reverse mode. ASR quick setting:

1. Quick press R/S button once to display current ASR level;
2. Quick double press R/S button to shift one ASR level, keep double press to switch in cycles.

G. Hazard Warning Lamp Switch

When the switch is pressed, the front and rear turn signals are all flash to warn others of situations, which include needing to stop or park under emergency conditions. When pressed again, the switch resets and the turn signals go out. (This is the headlight high beam switch on Ultra Bee X version)

H. ABS Button

For operations and instructions, please refer to "Starting and Operating" page 7.5.

I. Brake Lever Adjuster

Adjustment nut used to set brake lever position, by using 2.5mm hex key and 8mm open end wrench to adjust the brake lever position to fit the rider's riding habit.

J. Overtaking Button

This switch is self-return switch button. When the headlight is in the low beam position, press the button, the high beam is on, high beam indicator on the dashboard also illuminates. Release the button, high beam is off.

K. ASR (Traction Control System) Button

The Acceleration Slip Regulation (Traction Control System) can be adjusted by the ASR button in the left combination switch.

ASR button located behind the left combination switch, trigger switch. When ASR is off:

- 1.No action: ASR off.
- 2.Press and holding: ASR is turned on and active in the previous setting ASR level, release the button will disable the ASR.
- 3.Quick press 3 times: ASR is turned on, and locked in active state; quick press 3 times again, ASR will be turned off.

Feature Introduction

6.3

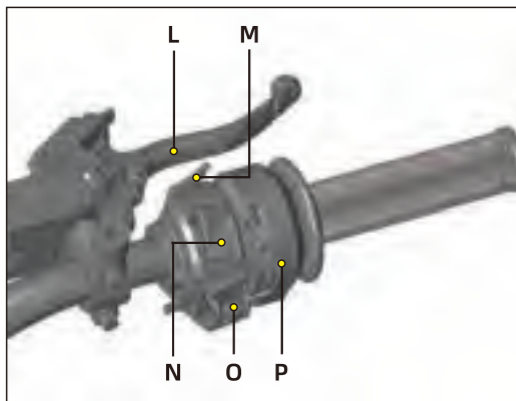

L. Front Brake Lever

When you pull or squeeze the brake lever, it controls the front braking system. When braking, the throttle should be in the idle position. The brake lights are also lit.

M. READY Button

When the motorcycle is in ready condition, press the button will make the motorcycle enter the riding state, The READY indicator also illuminates.

N. Motor Stop Switch

When pressed A on the top of the switch, it will cut off the power supply for the power train. The MCU remains in the no power output state until the B on the bottom of the switch is pressed. The switch does

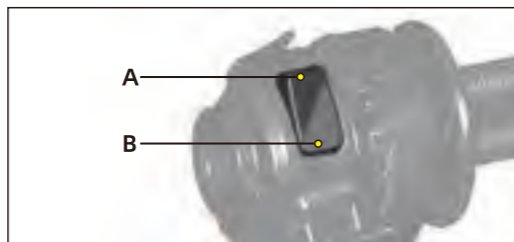

not switch off all operational functions, only cut off the power to the power train.

O. Riding Mode Switch

The Riding Mode Switch toggles between SPORT, ECO and DAILY riding modes. For instructions and operations, please refer to page 6.4 of "Feature Introduction".

P. Throttle Control

When the motorcycle is in READY state, twist the throttle in a counter-clockwise rotation start the motor and accelerate the motorcycle in a forward direction. Release the throttle and it snaps back to the idle position will stop the motor, decelerate the motorcycle. The throttle sensitivity level can be adjusted in the System Feature Mode, please refer to page 5.3 for details.

Feature Introduction

6.4

Riding Mode Switch

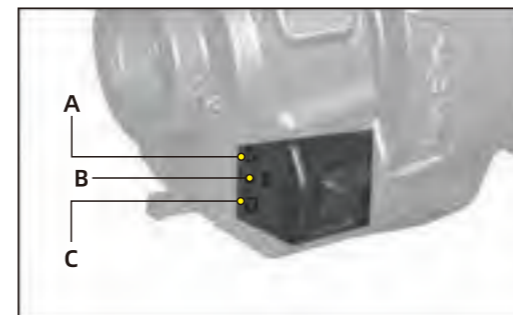

The Riding mode include SPORT mode S, ECO mode E and DAILY mode D. You can switch between Riding mode while riding, and there will be certain icon showing on the dashboard.

A. SPORT Mode S

Slide this switch to the top to enter the SPORT mode. This mode has strongest power output and acceleration ability. It is highly recommended using in trail or any offroad condition, users only use this mode after familiarizing themselves with the Ultra Bee motorcycle.

B. ECO Mode E

Press this switch in the middle to enter ECO mode. In this mode, the power and acceleration ability are much reduced, the Ultra Bee motorcycle is much easier to ride and maximized the cruise range.

C. DAILY Mode D

Slide this switch to the bottom to enter Daily mode. In this mode, the power output is reduced, accelerate more gently, suitable for daily riding.

Parking Brake Operation

Ultra Bee electric motorcycle is equipped a parking brake. When triggered, the parking brake system will prevent the electric motorcycle from rolling forward or backward. There are three gears for parking brake intensity, which should be selected according to different scenarios.



A. Parking Brake On

Squeeze the rear brake lever and push the parking brake lever, the brake gear will into the parking brake limiting slots, and release the rear brake lever.

B. Parking Brake Off

Squeeze the rear brake lever, the parking brake lever will automatically pop out of from the parking brake limiting slots.

Feature Introduction

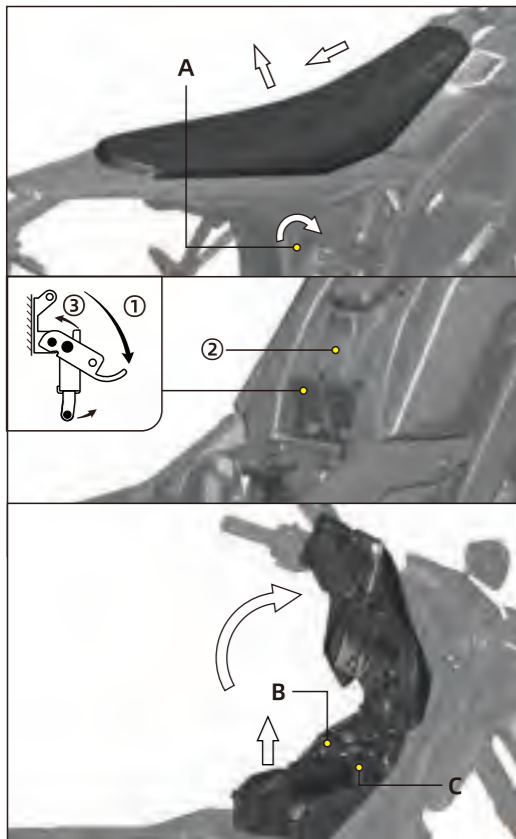

6.5

Battery pack removal!!!

1. Insert the key into the seat lock switch A, turn the key according to the arrow direction to unlock the seat lock.
2. After the seat springs up, lift the rear end of the seat up slightly, then pull the seat backward to remove the seat according to the arrow direction.
3. Press the battery compartment cover ① down, push two battery compartment cover clamp toggles ② downward and flick the latch of two clamps ③ forward respectively to disengage the latch from the hook, and then open the battery compartment case cover according to the diagram.
4. Remove the blue communication plug C and then the orange power plug B. Make sure disconnect the plug carefully and vertically to avoid damage to the connectors.
5. Lift up the battery pack up to remove the battery pack and put in the safe place.

Warning

Do not change the installation steps of the communication plug and the power plug at will. Remember don't connect or remove the power plug while the communication plug is plugged in. As the battery pack are high-voltage components, the wrong installation steps may cause serious damage or even personal injury.

Feature Introduction

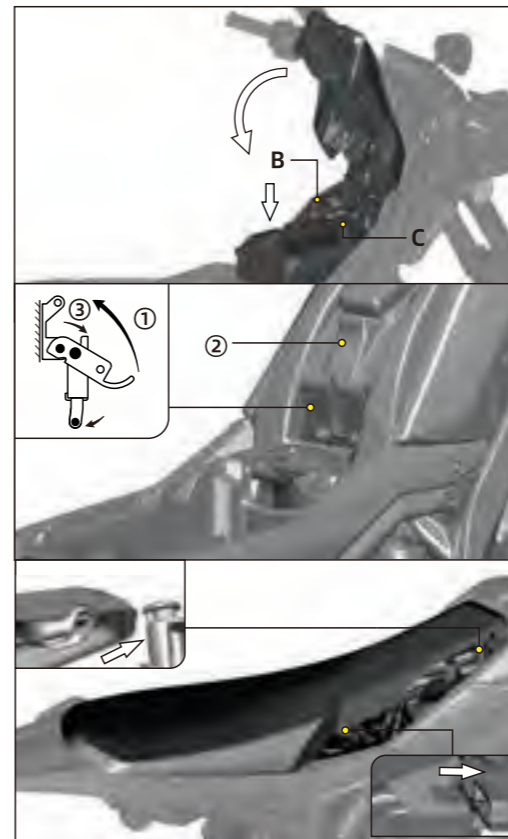

6.6

Battery pack installation!!!

1. Open the battery compartment cover and put the battery pack in the battery compartment.
2. connect orange power plug B first, and then blue communication plug C. Make sure inserting the plug carefully and vertically to avoid damage.
3. Close the battery compartment cover according to the arrow showing on the diagram and press the battery compartment cover ② down, then flick the latch of two clamps ③ backward respectively to engage the hook in place, and push two toggles ① upward to lock the battery compartment cover.
4. Push the positioning slot at the front of the seat into the front positioning bushing on Ultra Bee body, then align the hook in the middle of the seat with the positioning bracket on subframe. After that, push the seat forward in the direction of the arrow shown in the figure to install the positioning slot and hook in place. Press the rear end of the seat down to lock the seat.

Warning

Before removal or installation of the battery pack on the Ultra Bee motorcycle, the key switch must be in the OFF position, so that the whole motorcycle is in no power condition.

Charger Storage

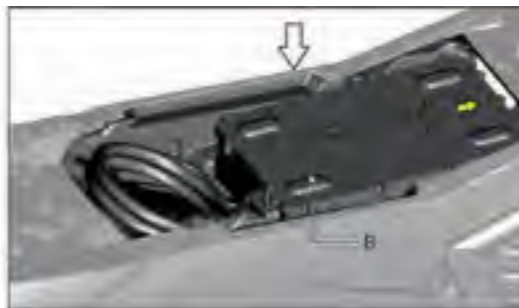

6.7

In order to provide Ultra Bee rider a better experience, there is a storage room designed on the Ultra Bee, which can be used to store the charger or other items.

1. Remove the seat. For description and operation, please refer to "Battery pack removal" .
2. Remove the input cable A from the charger and place it into the storage compartment.
3. Place the charger B in the storage compartment upside down (As shown in the figure, the direction of the charger is indicated by arrows and labels.) and store the output cable of the charger at the back of storage compartment. There is positioning structure of the charger designed for fixing the charger inside the storage compartment.

4. At last, install the seat back on the motorcycle, make sure the buffer foam on the bottom of the seat is fully secured with the charger. For description and how to install the seat, please refer to "Battery pack installation" .

Note

When installing the seat back in, make sure that the charger and cables are stored secured in place to avoid damage to the cable or charger.

6.8

Starting and Operating

Check before riding

Before operating the electric motorcycle, please check the following item to ensure that the Ultra Bee electric motorcycle is in operational condition:

Battery pack

Check that the battery level displayed on the battery pack or dashboard is sufficient enough to support your riding. We recommend you to fully charge before your next trip.

Chain

Check the chain tension and condition. Adjust or replace if necessary. Please refer to "Chain" on page 10.9.

Brake system

Squeeze the brake lever and push the motorcycle to see if the front and rear wheels are fully locked. You should be able to lock the wheels completely by braking.

Throttle

When the key switch is in the off position, twist the throttle and release it to check whether the throttle is move smoothly and return to idle freely.

Tire

Check the tire pressure and tread depth of the tires.
Check the cold tire pressure, maintain the correct tire

pressure, and check for damage and abnormal wear of the tire surface. As described on page 10.3, when the tread depth is reached the warning mark on the tire, please do not ride the motorcycle and replace the tire immediately.

Warning

Unusual tire pressure is a common reason that cause of tire failure, and may cause severe tires issues or loss the control of the electric motorcycle, which may result in serious personal injury. Check the tires regularly to ensure perfect tire condition.

Electrical System

Check whether the headlight, turn signals lights and brake lights/taillights are functioning properly.

Key switch

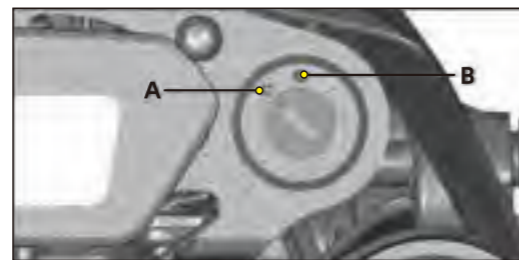

This is a two-position switch located on the right side of the dashboard. The functions listed below:

OFF A

ON B

OFF position

This position is to turn off the Ultra Bee electric motorcycle, thereby turn off all the electrical system. The key can also be removed from this position.

ON position

This position is to turn on the Ultra Bee electric motorcycle. The following changes occur when switch to this location:

Dashboard ON.

Headlight ON.

Taillight ON. (Not available for X version)

Operate Key Switch:

1. Insert the key into the key switch and turn clockwise to switch the key from OFF position to ON position, then start the Ultra Bee electric motorcycle.
2. When the Ultra Bee electric motorcycle is started, turn the key counterclockwise to switch the key from ON position to OFF position, then the Ultra Bee electric motorcycle is turned off.

Remove the key immediately after turn off the key switch and safely park the motorcycle to prevent the vehicle been stolen.

Starting and Operating

Steering Lock

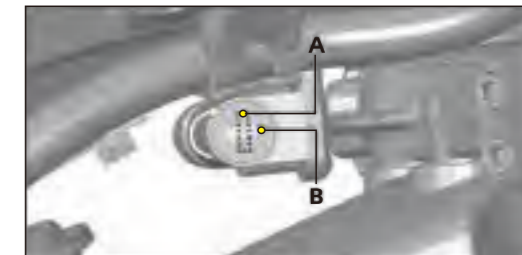

This is a two-position switch located on the back side of the lower triple clamp. The function is as follows:

Lock A

Unlock B

Lock Steering Lock:

1. Turn the handlebar to the left till the limit.
2. Lock the Ultra Bee electric motorcycle by insert the key into the steering lock and turn it clockwise.
3. Remove the key.

Unlock Steering Lock:

1. Unlock the Ultra Bee electric motorcycle by insert the key into the steering lock and turn it counterclockwise.
 2. Remove the key.
- Lock the steering lock after parking the motorcycle to prevent unauthorized use or been stolen.

Starting and Operating

Seat Lock

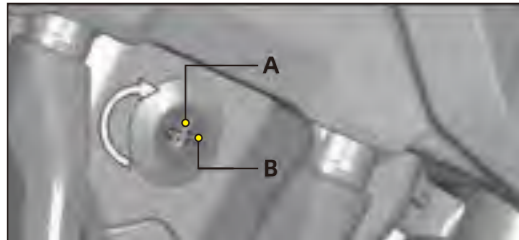

This is a two-position self-return switch located on the back of rear shock absorber. The function is as follows:

Lock A

Unlock B

Operate Seat Lock:

1. When in lock position, insert the key into the seat lock and turn clockwise to switch the key from lock position to unlock position. When the key is in unlock position, the seat can be removed.
2. When releasing the key, the key will automatically return from unlock position to lock position, and the key can be removed when in lock position.

Starting and Operating

Starting

1. Turn the key switch from OFF position to the ON position.
2. Confirm the battery percentage display on the dashboard.
3. Press the motor stop switch to the start position.
4. Gently squeeze the left rear brake lever to make sure that the parking brake is unlocked.
5. After confirming that there are no obstacles and passing vehicle in surrounding, lift the side stand, press the READY button to enter the READY mode, and the green READY indicator on the dashboard will light up, and twist throttle inward (counter clockwise) to increase the speed and riding.

Braking

The brake levers are located on the left and right handlebars.

When you pull the right brake lever, it controls the front brake.

When you pull the left brake lever, it controls the rear brake.

Warning

If ABS is disabled or been turned off, apply too much force to the brakes will cause the wheels to lock up. This may cause the tires lost traction and you will lose control of the electric motorcycle which may result in serious injury or even death.

Progressive use the brakes and control the applying force on the brake lever will gradually stop the electric motorcycle without locking the wheels. Your electric motorcycle is a powerful vehicle, so it is strongly recommended that you practice adequately, and familiar with all the safe emergency stop operation.

Park the Ultra Bee electric motorcycle

1. When the throttle is in the closed position, press the motor stop switch to the closed position.
2. Put side stand down in case of the vehicle tilt over.
3. Turn the key switch to the OFF position and remove the key, and keep it in a safe place.
4. Lock the parking brake to prevent the motorcycle from moving due to the gradient (it is recommended to use the parking brake no matter parking on flat ground or steep hill, this is a good parking habit and will keep your motorcycle safe).

Note

After each ride, please check the remaining energy and charge the battery pack in time.

Temperature Indicator

The electric motorcycle power system will generate heat during operation, to keep the Ultra Bee electric motorcycle can continuous operation. The Ultra Bee electric motorcycle will self-monitoring the temperature of each component of the power system, displayed on the dashboard, to ensure the power system operating through a comprehensive multiple thermal management strategy.

Temperature indicator on the dashboard A, indicates the power system temperature (battery pack, motor and MCU).

When power system temperature is over the temperature limitation, the entire temperature indicator A will start to flash.



Starting and Operating

ABS (Anti-lock braking system)

Warning

The ABS anti-lock braking system maximizes the braking efficiency in emergency situations and the safety during riding. Under certain conditions, ABS can shorten the braking distance, but it cannot be replaced by good riding habit and skills.

Please ride safely follow the local traffic rule and regulations and respect the legal speed limit on the road.

Ride cautiously when turning. If you braking while turning, ABS may not be able to offset the centrifugal force of inertia. Such activities will cause unsafe riding and easily cause accidents. Certain riding conditions and environments may reduce the braking efficiency of ABS and make its braking distance longer or even similar to the motorcycle without ABS.

ABS Switching ON/OFF conditions

- 1.The electric motorcycle is powered on;
- 2.The speed of the front and rear wheels of the motorcycle is zero;
- 3.The electric motorcycle is not in diagnostic mode.

ABS operation method

- 1.After turn the key switched ON, ABS is turned on by default.
- 2.When the ABS is in the OFF condition, the ABS indicator flashes slowly, when the ABS is in the ON condition, the ABS indicator is off.
- 3.When the ABS button is pressed for more than 3 seconds and not released within 5 seconds, the ABS ON/OFF switch request will be ignored and the ABS keeps the current state.
- 4.When the ABS button is pressed for more than 30s, the ECU of the ABS treats the switch signal as a fault signal, and the ABS returns to default ON state, the ABS indicator illuminate. The ABS can only be turned off after the power is switched OFF and ON again.

Disable ABS

1. In the parking state, put down the side stand.
2. Place the motor stop switch in the OFF position.
3. Turn the key to the ON position.
4. Press and hold the ABS button for 3 seconds and released within 5 seconds, now all ABS functions are turned off, and the ABS indicator flashes slowly.

Reactivate ABS

1. Every time the key switch is turned ON, the ABS system is activated by default.
2. Activating and deactivating the ABS system are the same operations, which can restore the ABS system from the OFF state to the ON state.

Warning

When ABS is disabled, the electric motorcycle will be able to operate as a motorcycle without ABS function, and the braking distance may increase.

Caution

When the ABS system is disabled, the ABS indicator will continue to flash slowly.

ABS indicator

- 1.When the ABS system detects a fault, the ABS fault indicator will illuminate. If the fault is eliminated, the ABS indicator will disappear when the motorcycle speed reaches 5km/h in the current states or turn on the key switch and reaches the speed of 5km/h next time.
- 2.When the ABS is in the ON mode and the speed of the electric motorcycle reaches 5km/h, the ABS indicator light goes out.
- 3.When the ABS is in the OFF mode, the ABS indicator flash slowly.
- 4.When the ABS button is been pressed, the ABS indicator flash rapidly, but when the ABS button is pressed and hole for more than 30seconds, the ABS indicator always on.
- 5.When the ABS is in the diagnosis mode, the ABS indicator is on.

Starting and Operating

Warning

ABS indicator flash slowly with frequency of 1 time per second, flash rapidly with frequency of 2 times per second.

Warning

When Ultra Bee electric motorcycle exceeds 5km/h, if the ABS indicator light is still on, it indicates that the ABS system is malfunctioning, and the ABS may not work normally. Please contact the Surron authorized dealer or workshop for service in time. When the ABS system is not working, Ultra Bee electric motorcycle will operate as a motorcycle without ABS, which may increase the braking distance and may even cause unpredictable conditions.

Warning

ABS work requires comparing the relative speed of the front and rear wheels. Failure to use the tires specified by the manufacturer may affect the ABS functions and also the braking distance of the Ultra Bee electric motorcycle.

Warning

If the speed of the front and rear wheels are greatly different, experience a wheel damaged accident or offroad riding, the ABS indicator will light up and ABS will be disabled.

Starting and Operating

Note

To reactivate the ABS, please stop the Ultra Bee electric motorcycle completely, then turn the key switch to the OFF position, wait for about 5 seconds, then switch back to the ON position. Once both wheels reach 5km/h and are fully functional, the ABS light should go out.

Front fork adjustment

7.7

Rebound damping

Adjust the rebound damping by turning the knob A at the bottom of the left and right front fork. The symbol "+" means increasing rebound damping, and the symbol "-" means reducing rebound damping.

Turn the rebound adjusting knob A clockwise in the "+" direction to increase the rebound damping, resulting in reduced the fork rebound speed.

Turn the rebound adjusting knob A counterclockwise in the "-" direction to reduce the rebound damping, resulting in increased the fork rebound speed.

Compression damping

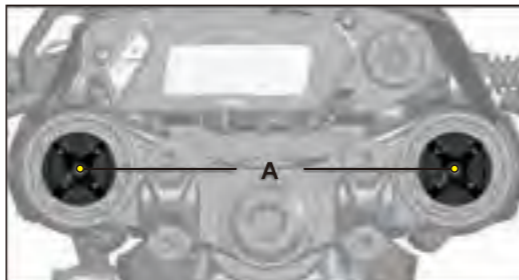

Note

The appearance of front fork may vary in different brands, please refer to the actual product.

Use a flat-blade screwdriver to turn the screws B on the bottom of the left and right front fork feet to adjust the compression damping. The symbol "+" means increasing compression damping, and the symbol "-" means reducing compression damping.

Turn the adjusting screw B clockwise in the "+" direction to increase the compression damping.

Turn the adjusting screw B counterclockwise in the "-" direction to reduce the compression damping.

Starting and Operating

Rear shock adjustment

Compression damping

The compression adjustment knob A is located on the top right side of the rear shock absorber. "+" is printed on the adjusting knob to indicate increasing compression damping and "-" indicates reducing compression damping.

Turn the adjusting knob A clockwise in the "+" direction to increase the compression damping.

Turn the adjusting knob A counterclockwise in the "-" direction to reduce the compression damping.

7.8

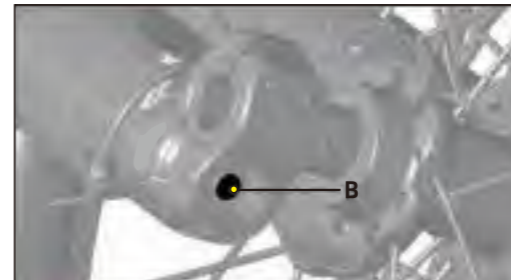

Note

The appearance of front fork may vary in different brands, please refer to the actual product.

Keep the left and right fork leg setting symmetric when adjusting the rebound and compression damping.

The damping and spring preload should be adjusted according to the road conditions and the weight of the rider. Avoid to adjusting the damping to the maximum limit value at all time, otherwise the front fork may malfunction or even lead to fatal or serious injury.

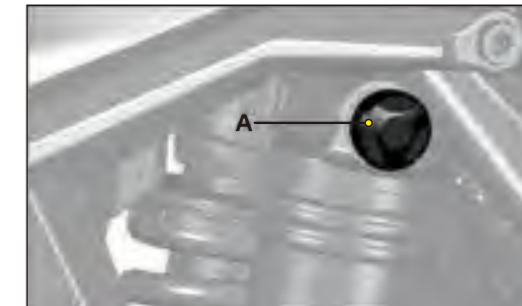

Note

The appearance of front fork may vary in different brands, please refer to the actual product.

Starting and Operating

Rebound damping

The rebound adjustment screw B is located at the bottom right side of the rear shock absorber using screwdriver to adjust the rebound. "+" printed on the adjustment screw means increasing rebound damping, "-" means reducing rebound damping.

Turn the adjusting screw B clockwise in the "+" direction to increase the rebound damping, resulting in reduced the shock rebound speed.

Turn the adjusting screw B counterclockwise in the "-" direction to reduce the rebound damping, resulting in increased the shock rebound speed.

7.9

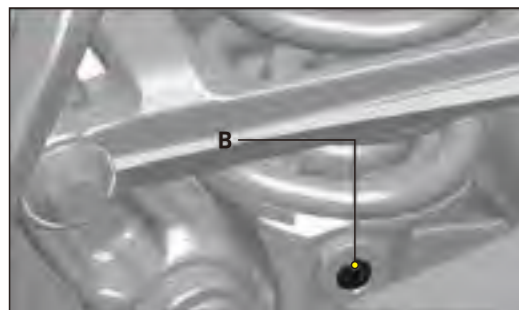

Note

The appearance of front fork may vary in different brands, please refer to the actual product.

Rear shock preload adjustment

1. Using adjusting wrench to loosen the spring lock ring A.
2. Use an adjusting wrench to turn the adjustment ring B.
3. Rotate the adjustment ring B counterclockwise to reduce the preload on the spring and rotate the adjustment ring B clockwise to increase the preload of the spring.
4. Using adjusting wrench to tighten and lock the spring lock ring A.



Note

The damping and spring preload should be adjusted reasonably according to the road conditions and the weight of the rider. Avoid adjusting the damping to the maximum limit value at all time, otherwise the shock absorber may malfunction or even lead to fatal or serious injury.

Rear shock adjustment

Battery Pack

The Ultra Bee electric motorcycle uses high-performance and high rated lithium-ion battery which can be used in the ambient temperature range of $-20^{\circ}\text{C} \sim 45^{\circ}\text{C}$, the best working condition is when ambient temperature is between $10^{\circ}\text{C} \sim 30^{\circ}\text{C}$. Ambient temperature too low or too high will affect the battery pack performance and life span. Do not use it at temperatures beyond the allowable range, and do not charge the battery pack below 0°C .

The charge time of the battery pack is about 4.5h in normal ambient temperature.

When the ambient temperature is too low, the performance of the battery pack will be affected. It is normal to reduce the range a little, and the performance of the battery pack will automatically recover after the temperature rises back to working condition.

When battery pack not in use for a long time of period, please charge the battery to 60% ~ 80% of the full battery capacity, and you will need to check the remaining battery percentage every month. Must recharge the battery pack to 60% ~ 80% of the full battery capacity if the battery state of charge drops below 30%, in case damaged the battery pack permanently and reduce the battery performance and lifespan.

It is strictly prohibit to wash the battery pack with a high-pressure water pump or compressed air,

especially all the connectors and cables, do not put the battery inside of the water. The water should not exceed the height of the center of the wheel if riding in the flood water, otherwise it may cause water ingress in the battery pack, internal short circuit and permanent failure of the battery pack.

If water ingresses into battery pack or battery pack had other faults, it is strictly prohibit to charge the battery pack again. It may cause the risk of fire hazard, combustion and explosion of the battery pack and lead to fatal or serious injury.

The battery pack is water resistant and sealed with a high voltage circuit inside. If the external structure is damaged this will reduce the water-resistant performance of the battery pack. If the water-resistant structure is damaged, please contact the Surron authorized dealer or Surron Service department. It is strictly prohibit for customers to open or disassemble the Lithium-ion battery pack, to avoid potential damage and serious danger.

8.1

Power Management

Warning

There is a risk of electric shock when working on high-voltage components. The motorcycle's high voltage system has no user serviceable parts. Work on high-voltage components requires certain qualifications, special training and tools, or by law in some country or region.

Note

The battery pack contains components and elements that might harm the environment, please dispose of the battery pack properly and in compliance with applicable regulations. Never throw the battery into the household trash bin.

Power Supply and Charging

Before charging, please check whether the input voltage range of the charger is compatible with the grid voltage, AC 85 ~250V / 200~240V.

Before charging the battery, ensure the battery is placed on a flat, firm surface, and the battery charger is adequately ventilated.

Before charging, please check whether the load power of AC power network can meet the power requirements of battery charger.

When charging, please connect the battery pack plug first, then connect the AC power plug.

If you ride a long time in hot weather (>36°C) or spend a majority of your ride at highway speeds, do not charge right after the battery pack will benefit from not being charged "hot". Allowing your pack a few hours to cool off prior to recharging will prolong its life. You may also benefit from off-peak electricity rates by waiting until the evening to charge.

You can directly plug the charger into the battery charging port A on the left side of the motorcycle.

The charger will turn off automatically when the battery pack is fully charged. Please disconnect the power supply of the charger and disconnect the charging plug.

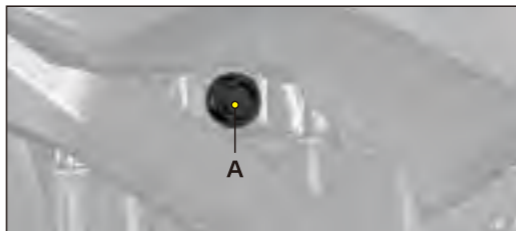

Charging Precautions

When charging, please put it in a safe place and beyond the reach of children.

Power Management

only be charge after the temperature of the battery pack rises back to above 0 °C. The maximum charging temperature inside the battery pack is 55 °C. If the internal temperature of the battery pack exceeds this temperature, it can only be allowed to charge after cooling back to below 55 °C. If the battery pack is discharged rapidly due to heavy duty riding, the internal temperature of the battery pack may still be higher than 55 °C even the ambient temperature is lower than that.

The battery pack is only allowed to return to normal temperature by itself. Do not use other methods to raise or lower the temperature of the battery pack.

The battery pack may not be able to charge immediately after high power output or high temperature operation. Should let the battery pack cool down for 30 minutes or longer before charging. The battery management strategy does not allow charging when the internal temperature exceed the temperature limitation, otherwise the battery pack might be damaged and reduce the battery pack lifespan.

Avoid using the battery pack when it has just finished charging. It is highly recommended to put the motorcycle or battery pack in a well-ventilated environment and let it cool down for at least 10 minutes after it is fully charged.

It is prohibit to cover any object when charging. This charger is for indoor use. Please use it in a dry and well-ventilated environment.

After charging, please put the charging socket protection cap back on.

Warning

Always charge the battery pack in a well-ventilated environment and far away from any fire hazard. Do not charging in the rain, humidity condition, direct sunlight or any other extreme weather condition.

The battery pack can only be charged with an original charger supplied with the original manufacturer or specified charger authorized by Surron. The use of unauthorized chargers or accessories may cause damage or failure of the battery pack, or even and lead to fatal or serious injury.

Do not charge the battery pack below 0 °C, otherwise it will damage the battery pack. It can

----- **Serious Warning!** -----

When you find the following situations, please stop charging immediately, disconnect the power supply, and do not use the electric motorcycle. Contact the Surron authorized dealer and workshop or Surron service department for inspection and service immediately.

Massive mechanical damage to the battery pack or spotted the damage on the case of the battery pack.

Strange smell during charging.

The temperature of the battery pack or charger is too high.

Charging cannot be complete for a long time.

There is no particular fire hazard for this motorcycle when the battery pack is intact, but if the motorcycle or battery pack is catch fire, please throw the battery pack into the water to prevent more damage, also inform the local fire department and explain the fire source.

Power System //

The Ultra Bee electric motorcycle power system include MCU and motor.

----- **Warning** -----

The customer is not allowed to disassemble the motor without Surron authorization, otherwise may cause the position sensor malfunction or damage the corresponding seal which can lead to motor malfunction.

The MCU is a precision high-voltage and high-current electronic component. Incorrect wiring connection and wrong screw torque may cause damage to the MCU or power system.

Disassembling, removing or replacing power system component, cables or connectors can cause severe burns or electric shock that may result in serious injury or death.

The power system of the Ultra Bee electric motorcycle must be repaired or replaced by a trained professional technician authorized Surron. Customer are not allowed to disassemble and modify the power system of the Ultra Bee electric motorcycle. It's prohibited to put the power system into the water, otherwise it will cause severe damage.

Power cables had high current during operation, do make sure the cables are correctly and firmly connected, ensure that the torque and tightness of cable fastening bolts meet the recommended torque requirements and cable insulation also meet the requirements. Disassembling, removing or replacing power system component, cables or connectors can cause severe burns or electric shock that may result in serious injury or death.

The power system is a 74V high voltage system and the power cable is in orange colour for easy identification. During operation, repair and maintenance or cleaning the motorcycle, it is necessary to ensure that the electric motorcycle and power cable is well isolated.

Maintenance

Maintenance Item

The proper replacement fluids are listed in the table below.

Parts	Oil type	Volume
Brake fluid	DOT4	

Maintenance Records

Please follow the maintenance schedules refer to page 10.2. After each scheduled service or maintenance is performed, record all the information in the Maintenance schedule of this manual.

Scheduled Maintenance

Maintenance of the Ultra Bee electric motorcycle must be scheduled to ensure the safe, reliable performance. The required maintenance schedule that follows, specifies how often you should have your electric motorcycle serviced and what items need attention. If you do not have enough experience or tools, contact the nearest local Surron authorized dealer to maintain your motorcycle. Your warranty will be void if damage, malfunctions, or performance problems caused by the improper maintenance or repair of the electric motorcycle.

The service intervals in this maintenance schedule are based on average on road riding conditions. Some items will need much more frequent service if

you ride in unusually wet, dusty areas, trail or dirt track offroad riding. Consult your local dealer for recommendations applicable to your individual needs and use. It is recommended that you maintain your Ultra Bee electric motorcycle at least once every 6 months by your local Surron authorized dealer, regardless of the distance ridden.

Maintenance Schedule

To maintain the best condition of your motorcycle, regular inspection and service is required as shown in the Maintenance Schedule table below. The initial maintenance is vitally important and must not be neglected. Where time and mileage are listed, follow the interval that occurs first.

Attention

1. The battery compartment cap gas strut must be used at least once every 5 months.
2. It is recommended to check the tightening torque of all the screw and bolts before every dirt track or trail ride.

Maintenance

Ultra Bee Electric Motorcycle Maintenance Schedule

Check item	every rider	every 100km	every 500km	every 2000km	every 5000km	every 10000km /12months	every 20000km /24months
Tire(worn)	●						↻
Brake pads (worn)		●	●	●	●/↻	●/↻	↻
Brake disc (worn)			●		●/↻	●/↻	↻
Chain		●/⚙️	●/⚙️	●/⚙️	●/↻	●/↻	↻
Sprocket (front and rear)				●	●/↻	●/↻	●/↻
Primary belt and primary drive pulley				●/⚙️		●/↻	↻
Battery pack voltage	●						
Dashboard warning code	●						
Front fork and rear shock	●				●/⚙️	●/⚙️	
Brake fluid		●		●		●/↻	
Bearing				●	●/⚙️	●/↻	
Lights	●						
Wheel spokes	●	⚙️			⚙️	⚙️	
Swingarm protection block				●		●/↻	●/↻
Tilt switch				●			
Screw torque				●			

● Check ↻ replacr ⚙️ adjustment 🔧 manintenance

Torque Management

Check regularly and tighten the following fasteners on the Ultra Bee electric motorcycle according to the specified torque.

Note: Steering tube lock nut adjustment method:

1. Put the motorcycle on the support stand to lift the front wheel off the ground;
2. Loosen the steering tube lock nut and the front

fork lock bolt on the upper triple clamp;

3. Tighten the steering tube adjusting nut to 20N.m and then loosen it by 1/4 turn;
4. Tighten the steering tube locking bolts and the front fork mounting bolts on the upper triple clamp;
5. Check whether the handlebar turns smoothly or not and repeat the above operation if necessary.

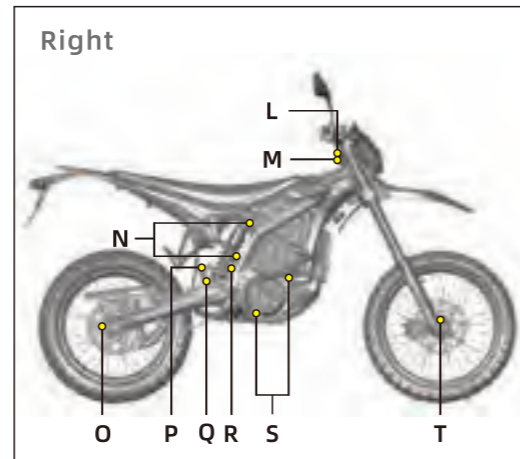
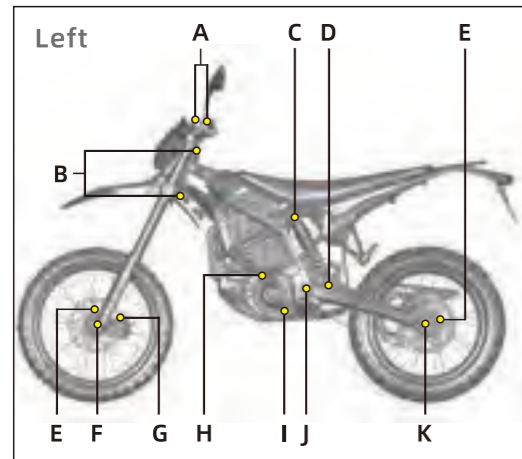

Please refer to page 10.4 Torque management.

	Item	Torque	Specification	Instructions
A	Handlebar installation screws	25N.m	Hexagon socket M8*25	/
B	Front fork installation bolts	13N.m	Hexagon socket M6*25	/
C	Rear shock absorber installation axle top	60N.m	T-shaft bolt M10*1.25-60	/
D	Rear shock absorber installation axle bottom	60N.m	Hexagon flange bolts M10*1.25-50	/
E	Brake disc installation screw	10N.m	Torx pan head screw M6*16	Thread locker needed (e.g. KAFUTER K-0609 or similar products)
F	Front axle	60N.m	Step-shaft axle inner thread M16*1.5-170	/
G	Front brake caliper installation bolts	25N.m	Hexagon socket M8*35	/
H	Motor front left installation screw	25N.m	Hexagon socket M8*50	/
I	Motor rear left installation screw	25N.m	Hexagon socket M8*55	/
J	Swingarm pivot	60N.m	Hexagon socket M11*1-230	/
K	Rear wheel axle	140N.m	Hexagon socket M20*1.5-240	/
L	Steering tube locking bolt	70N.m	T-shaft bolt inner thread M20*1*17.5	/
M	Steering tube adjustment nut	/	T-shaft bolt outer thread M30*1*8	See previous note
N	Subframe installation screw	25N.m	Hexagon socket M8*20	Thread locker needed (e.g. KAFUTER K-0609 or similar products)
O	Rear sprocket installation screw	25N.m	Hexagon socket M8*16	/
P	Link rod connecting axle	60N.m	Hexagon flange bolts M10*1.25-67	/
Q	Triangular cantilever installation axle	60N.m	Hexagon flange bolts M10*1.25-75	/
R	Link rod installation bolt	40N.m	Low profile hexagon socket M10*35	/
S	Motor right installation screw	25N.m	Hexagon socket M8*35	/
T	Front axle locking nut	12N.m	Hexagon socket M6*25	/

Battery Pack

Caution

1. Battery packs are lithium-ion systems that do not require maintenance but need to be recharged from time to time. When not in use for a long time, please charge the battery pack to about 60% ~ 80% of the power storage. You will need to check the remaining power every month. If the battery pack power drops below 30%, it should be recharged to 60%~ 80% to prevent the battery pack from losing activity, which will affect performance and cause damage.
2. The battery pack should be kept away from high temperature environments. Do not store it in high temperature environment or under direct sunlight. When not used for a long time, please store the battery pack in an ambient temperature of 10°C ~30°C.
3. Only a service agent authorized by the manufacturer can be qualified to repair or dismantle the battery pack.
4. Dispose of the battery packs please according to your local laws. The used battery pack is encouraged to be handled and recycled by professional company or organization and not discarded at will.

10.5

Brake System

This chapter introduce how to maintain Ultra Bee motorcycle brake system. Which covers ABS (anti-lock braking system), brake pads (front and rear dedicated brake pads) and recommends brake fluid volume and types for front and rear brake systems.

Brake System HCU

Ultra Bee electric motorcycle equipped with ABS, only when the HCU (hydraulic control unit) is filled with brake fluid can the braking system operate efficiently. To fill the HCU with brake fluid, a vacuum pump and a filling machine are needed. Users need to bleed air from the HCU. This should be taken to the designated authorized dealer for the work to be carried out.

Brake Fluid Check

Brake Oil Cup



Check through the oil level inspection window B to observe the level of brake fluid. If the fluid level is significantly lower than one-third of the oil mirror, brake fluid must be added. Before opening the oil cup, please clean all dust or debris on the lid A to avoid contaminating the brake fluid.

A low fluid level may indicate worn brake pads or a leak in the hydraulic system. Check whether the brake pads are worn and/or the hydraulic system is leaking. Only use the new DOT 4 brake fluid in a sealed container.

The steps to add brake fluid are as follows:

1. Unscrew the two screws on the upper cover of the oil cup, remove the upper cover of the oil cup and the oil cup gasket.
2. Add new DOT 4 brake fluid.
3. Check the lid seal to make sure that there is no wear or damage, and the position is correct.
4. Install the upper cover screw of the oil cup (torque 4N.m).

Caution

Do not splash the brake fluid on the painted surface, it may damage the painted surface. Spilling brake fluid on plastic products can cause it to corrode. Before removing the cover, be sure to put an oil absorbent towel under the main cylinder reservoir.

Before checking the liquid level, the Ultra Bee

electric motorcycle should be in a flat and upright state and the handlebars should be turned back to ensure that the oil cup is in a horizontal position. When adding new brake fluid, if the brake fluid overflows, it should be removed immediately to prevent contamination of other parts.

Brake Disc Inspection

The brake disc must be checked at the specified intervals in the maintenance scheduled, The minimum thickness of the brake disc is 2.5mm.

Brake Pads Inspection

The brake pads must be checked at the specified intervals in the maintenance scheduled, please refer to page 10.2. Check the remaining amount of brake pad material visually from the side of the brake caliper.

If the thickness of the front brake pad is less than 1mm and the thickness of the rear brake pad is less than 1mm, replace the brake pads. If the metal part of the brake pad A is damaged, please replace the two brake pads immediately.

Brake Pad Replacement

It is recommended to check and run-in after replacing new brake pads or brake discs to ensure that the brake discs and brake pads adapt and match

10.6

Maintenance

again. Correct run-in can improve the brake feel and reduce or eliminate brake noise.



10.7



Front Brake Pad

Rear Brake Pad

Warning

When using a new brake system or new brake pads, the initial braking force may be too small. Please try to run-in the brake pads and brake discs at low speed and safety to ensure that the brake system provides normal braking force.

Parking Brake

The Ultra Bee electric motorcycle is equipped with a parking brake. When the rear brake lever is in the depressed position, it will lock the rear wheels. Please check the parking brake regularly.

Parking Brake Inspection

1. Raise the Ultra Bee electric motorcycle on the support bench to make the rear wheel off the ground.
2. Firmly hold the rear brake handle.
3. Push the rear brake parking paddles firmly into the parking position until it can no longer be pushed.
4. Release the rear brake handle, and then release the parking brake paddles.
5. The motorcycle can be parked successfully at this time, and different parking gear has different braking force.

Warning

If the parking brake cannot effectively lock the rear wheel, please contact an authorized dealer or after-sales service in time.

Maintenance

Suspension System

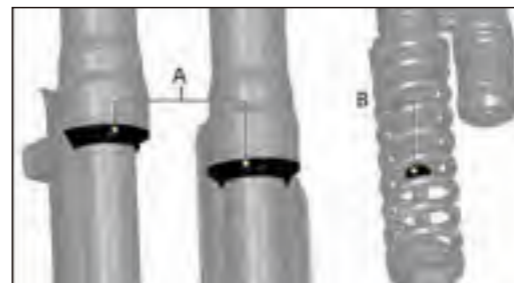

1. It is recommended to clean the surface of the shock absorber immediately after each ride, especially the mud and sand attached to the surface of the main tube. When cleaning with a high-pressure water gun, it is strictly prohibited to flush upwards facing the dust-proof seal A and B, as this will flush mud and sand into the oil seal and cause wear and oil leakage.
2. Do not use flammable or corrosive solvents to clean otherwise it will cause damage to the dust-proof oil seal. It is recommended to use a neutral detergent and a soft cotton cloth to assist in cleaning.
3. It is recommended to apply a layer of lubricating grease on the surface of the main pipe after cleaning to make the surface of the main pipe fully lubricated.

Warning

The shock absorber contains high-pressure gas or liquid.

Do not try to tamper with or disassemble the shock absorber.

Please avoid impact, high temperature or open flame on the gas cylinder.

After riding the motorcycle, the shock absorber and the gas cylinder may be in a high temperature state, please avoid burns.

Improper operation of the shock absorber may cause damage or serious personal injury. For maintenance, please refer to the maintenance scheduled on page 10.2. Please refer to page 7.7 for adjustment.

Wheels and Tires

Check the both wheels for the following:

The rim is bent, distortion or cracked.

There are impact marks on the rim.

Loose, bent or missing spokes.

There are cuts, cracks, penetrated, splits or missing tread blocks in the tread or sidewall area.

Tire bulge, bumps or even exposed tire thread or cords.

10.8

Maintenance

The tire tread wears are unevenly.

The height of the Tire installation mark is uneven.

If you find any of the conditions above, please replace the wheels or tires immediately.

Tire Pressure

Warning

Incorrect tire pressure is a common cause of tire failure. Riding long time with incorrect tire pressure may lead to tire damage, separation of the tread or even loss control of the motorcycle, resulting in serious personal injury and damage.

Before each ride, check the tire pressure and adjust it to an appropriate tire pressure level. When the tire is cold, use an accurate pressure gauge to check the tire pressure.

Recommended Tire Pressure Table

Recommended	Front wheel	Rear wheel
Off-road tires	225kPa	225 kPa
All-terrain tires	225kPa	225 kPa

Note: The recommended tire pressure range for off-road tires is 100 ~ 150 kPa for dirt track or trail riding scenarios.

Chain

Please refer to the maintenance scheduled on page 10.2 for the inspection and maintenance of the chain.

1.Check for chain dirt accumulation, keep the chain and sprockets clean.

2.Check the chain wear, tightness and lubrication.

(1) After turning off the motor stop switch, turn off motorcycle key switch and removing the key from the motorcycle, use a motorcycle lift stand to raise the motorcycle so that the rear wheel hangs in the air. Move the chain up and down by hand and check whether the chain tension is within the recommended range: 10-25mm.

(2) Adjust Chain tension if the chain tension does not meet the specification. When adjusting, first loosen the rear wheel axle nut, and then adjust the left and right adjusting bolts to adjusting the chain tightness within the recommended range.

(3) Use an appropriate amount of chain oil or chain wax to lubricate the chain.

Caution

1.When the chain tension exceeds the recommended range, the chain moves up and down during riding will damaged the swingarm protection rubbers on the swingarm. Please

adjust it in time to prevent further damage.

2.After adjustment, the left and right chain adjuster marks should be symmetric to the mark on the swingarm.



Chain Adjustment Procedure

- 1.Use a lift stand so that the rear wheel hangs in the air, turn off the motor stop switch and remove the key from the key switch.
- 2.Loosen the rear axle nut C.
- 3.Loosen the locknut A of the left and right adjusting bolts B.
- 4.Adjust the left and right adjusting bolts B equally until the chain is adjusted within the specified range.
- 5.Tighten the rear axle nut C.
- 6.Tighten the left and right lock nuts A to fix the position of the adjusting bolt B.
- 7.Test ride the motorcycle.

Maintenance

8.After the trial ride, please recheck whether the chain is adjusted correctly, and re-adjust if necessary.

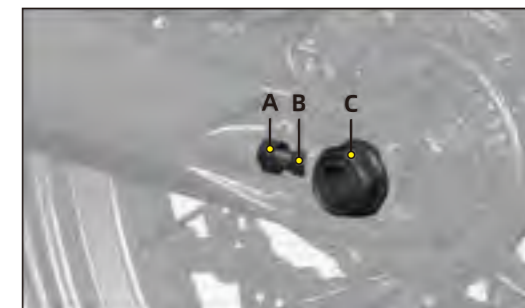

Caution

When adjusting the tension of the chain, adjust the adjusting bolts on both sides equally.

Headlight Adjustment

The angle of the headlights should be checked regularly. It must be re-adjusted after changing the angle of the whole motorcycle at any time because changes in the angle of the whole motorcycle will affect the angle of the headlights. Before adjusting the headlights, the suspension system and tire pressure must be adjusted correctly. The illumination angle of the headlight can be adjusted vertically. If the illumination angle of the headlight is not

Maintenance

suitable, it will cause the beam to point too close or too far.

Headlight angle adjustment:

1. When the headlight is in the low beam position, the motorcycle is perpendicular to the ground.

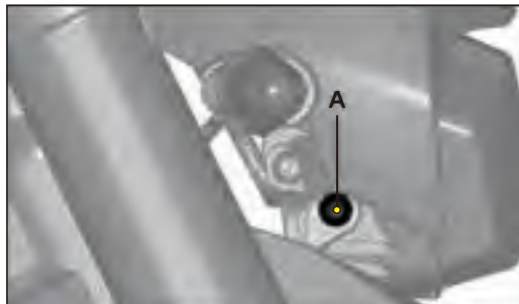

2. With the operator sitting on the motorcycle, check the beam angle.

3. To adjust the illumination angle of the headlight, please turn the adjusting screw A which is located at the both sides of the headlight until the correct beam angle is reached.

4. The correct illumination angle is when the near bright and dark cut-off line is 0.7-0.95 meters height from the ground while the motorcycle headlight is 10 meters away.

Light Replacement

When the headlight A/turning signal B/tail light or brake light C is damaged, please contact a Surron authorized dealer for a complete replacement.

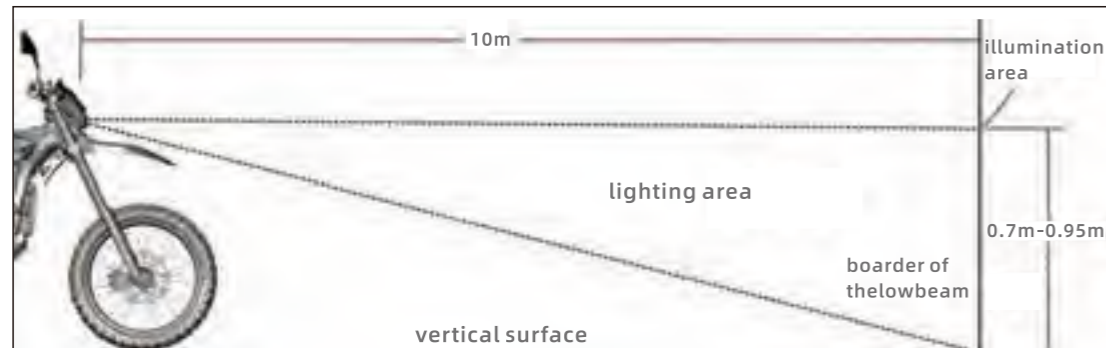

Maintenance

leakage.

After cleaning the motorcycle, please maintain the chain and other parts that need to be lubricated. Please let all electrical components completely dry before operation. If the Ultra Bee electric motorcycle is ridden immediately after cleaning, use the brakes several times at a safe and low speed to remove the water or other objects on the brake pads.

Note

Improper cleaning can damage motorcycle parts. Do not use high-pressure washer to flush bearings, seals, electrical components and plugs. In order to extend the service life of the Ultra Bee electric motorcycle, it should be cleaned and maintained regularly and it is recommended to wipe it dry as soon as possible after cleaning.

Note

Do not use any harsh chemical products on plastic parts. Avoid using strong corrosive cleaners, solvents or thinners, fuel (gasoline), rust removers or inhibitors, brake fluid, antifreeze in contact with Ultra Bee electric motorcycle to avoid damaging certain parts. We recommend that you carefully use the high-pressure washer to clean the Ultra Bee electric motorcycle to avoid damaging the motorcycle parts. After cleaning and before starting to ride, make sure the brakes system function properly.

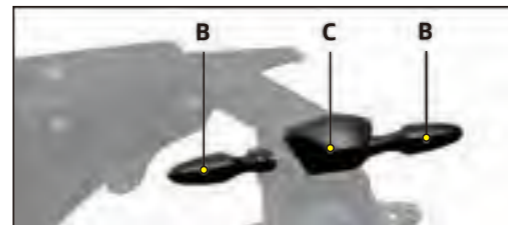
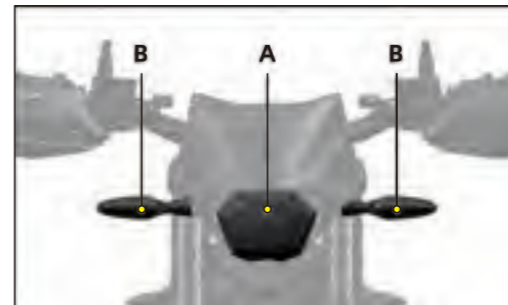

Motorcycle Cleaning

1. Use a sponge or clean soft cloth, neutral detergent and water to gently clean the motorcycle.
2. Be extra careful when cleaning the dashboard, it is easier to scratch than other parts of the motorcycle.
3. After cleaning, rinse the motorcycle thoroughly with water to remove all detergent residues.
4. Dry the motorcycle with a soft dry towel.
5. After cleaning, check for damage, wear or any

Maintenance

Warning

After cleaning and before starting to ride, make sure the brakes system function properly.

Wheel and Tire Cleaning

Avoid using strong acid wheel cleaners. If you use this type of product to clean stubborn dirt, please try to clean it in a short time and dry it immediately.

Warning

Tires only need to be clean. Any tire shine/ strong acidic chemical products may reduce the friction between the tire and the ground, and even reduce the service life of the tires.

Long-term Storage

For motorcycles that have not been used for a long time (more than 30 days), it is recommended to charge to about 60% to 80% of the battery state of charge (SOC), and disconnect the cable between the Ultra Bee electric motorcycle and the battery pack.

The battery pack also discharges slowly when stored. Check the power of the battery pack at least once every month. If the power drops below 30% of the battery state of charge (SOC), it should be recharged to 60% to 80%. When you are ready to use the Ultra Bee electric motorcycle again, please fully charge the battery pack to ensure that the battery

pack is restored to its best condition.

In order to extend the service life of the power system, the Ultra Bee electric motorcycle should be stored in a cool and ventilated place. Storing the Ultra Bee electric motorcycle in a hot or humid place will shorten the life of the battery pack and electrical system. For more information about batteries and electrical systems, please refer to page 8.1.

Caution

Do not store the Ultra Bee electric motorcycle with a battery power lower than 30% of the battery state of charge (SOC). Discharging the battery pack below 30% for a long period of time may reduce the lifespan of the battery pack or even damage the battery pack. Inappropriate store or maintain such as over-discharge or long-term extremely low SOC will damage to the battery pack and also not covered by the warranty.

Warning

Only Surron authorized professionally trained technicians can provide maintenance services to the battery pack. Please note that unauthorized handling of the internal components of the battery pack is dangerous. Do not disassemble the battery pack!

Ultra Bee Electric Motorcycle Parts

Ultra Bee electric motorcycles parts or accessories are designed to complement and function with other system on the motorcycle, it is requiring the use of specified parts or accessories by the manufacturer. You can obtain original spare parts for maintenance of the Ultra Bee electric motorcycle from your local Surron authorized dealer.

Fuse

The motorcycle electrical system has a multi-channel overloaded protection device. The fuse used is a one-time protection device, which will melt and protect when the circuit is overloaded. When replacing the fuse, use the same specification model.

Caution

If the fuse melts repeatedly, please contact the local Surron authorized dealer to check the electrical system.

Low Voltage Fuse Box

The low voltage fuse box is located under the USB cover.

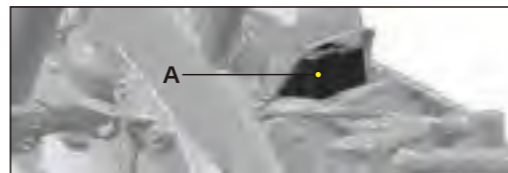

Maintenance

The fuse box has a protective cap, which must be opened first to access the fuse. To open the cap, press down the tab on the side of the box firmly to open the cap.

Replace a Low voltage fuse:

1. Pinch the fuse box and open the fuse box cap to the right of the fuse box.
2. To replace the defective fuse, you need to replace the fuse of the same specification.

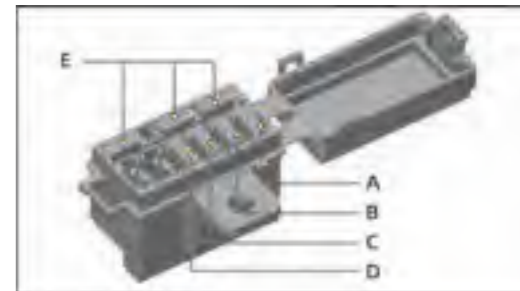

The 12 volt fuse value and corresponding circuit function are listed below:

Fuse	Rating	Function
A	10A	Motocycle main fuse
B	3A	Dashboard
C	20A	ABS Power
D	20A	ABS Motor
E	3A/10A/20A	Backup

Motorcycle Electrical Circuit Diagram Troubleshooting

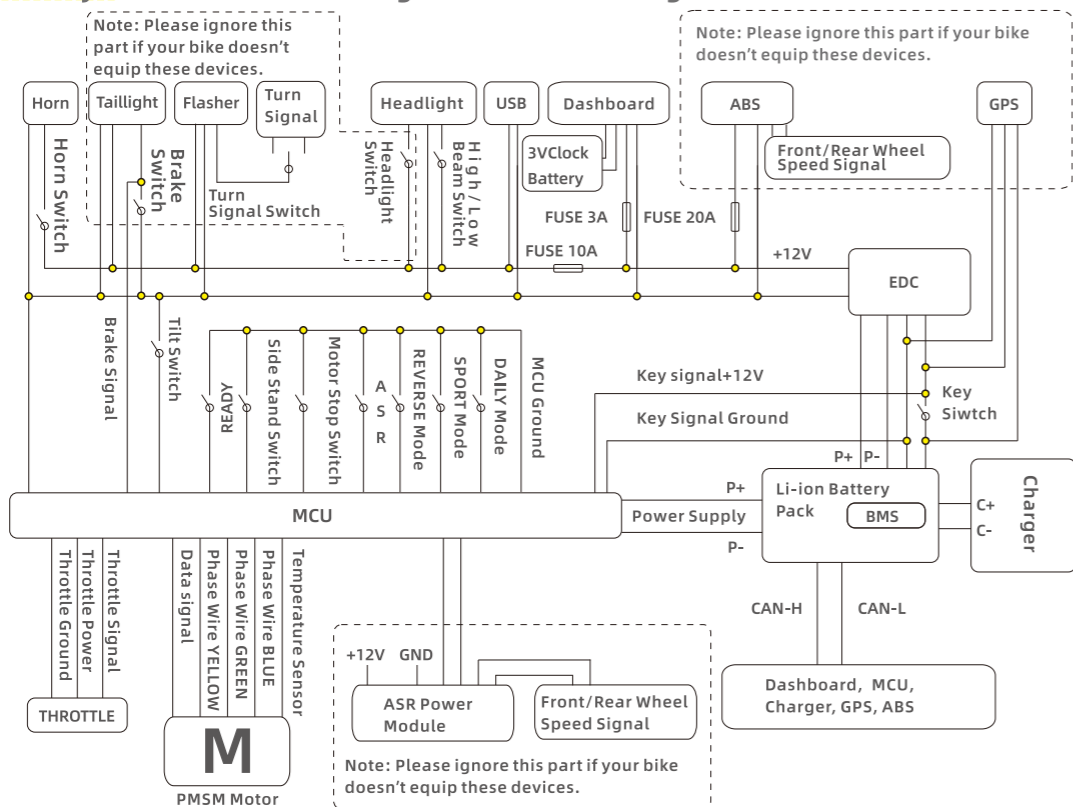

Ultra Bee Electric Motorcycle Troubleshooting

All Ultra Bee electric motorcycles are carefully inspected before delivery. Even the Ultra Bee electric motorcycle is carefully inspected, some technical problems may occur sometime. The following information provides guidelines to help you identify problems and do the basic repairing or maintenance. If you are unable to solve the problem by yourself, please contact and bring it to an local Surron authorized dealer at your convenience. If there is no dealer in your area, call the manufacturer customer service.

Temperature Precautions

Cold Weather

The cold weather will not permanently affect battery capacity. However, riders may find their range and power reduced as cold temperatures have an impact on the amount of energy the battery pack can release.

Therefore, when used in an environment below 0°C compared to an environment at 25°C, the motorcycle may temporarily reduce its effective range by about 30%.

In extreme cold weather, the Ultra Bee motorcycle may also temporarily reduce power and fail to reach top speed.

It is not recommended to ride the motorcycle when the battery pack temperature is below -5°C. If ridden

at low temperatures, the battery pack must be placed at ambient temperatures above 0°C for charging. The battery management system (BMS) does not allow the battery pack to discharge below -20°C, it's the strictly limited standard specified by the battery manufacturer.

It is recommended to store the Ultra Bee electric motorcycle in a suitable temperature environment.

The motorcycle can be stored in the following conditions:

1. Ambient temperature should never be lower than -20°C, it is recommended not even below 0°C.

2. Before storage, charge the battery pack to 60% ~ 80% of the battery state of charge (SOC). You should check its battery SOC at least once a month. If the battery pack power drops below 30%, it should be recharged to 60% ~ 80%.

3. The battery pack can only charge at ambient temperatures is above 0°C. Storage temperatures below -20°C may permanently reduce the battery pack performance. Keep the temperature above -20°C and following long-term storage guidelines (please refer to "Long-term Storage" on page 10.15) will ensure that the battery pack in good condition during winter storage

Hot Temperature

In high temperature condition, the battery won't have any performance changes. However, when the battery internal temperature is higher than 55°C (real

Troubleshooting

time value), the battery management system will immediately stop the battery discharging to avoid damage.

The charger will protect the battery pack by lowering the charging power when battery internal temperature is above 55°C, which may increase the charging time. When the battery internal temperature exceeds 55°C, the battery management system will no longer accept charging.

Caution

During charging, to prevent battery pack been damaged, battery management system (BMS) will stop charging when ambient temperature is lower than -5°C. Please remember battery will not be serious damaged when ambient temperature is over -20°C and the battery state of charge (SOC) is also over 30%.

Please do not place the electric motorcycle or its battery in an environment temperature higher than 41°C or in direct sunlight for an extended period of time, which may causing the degradation of battery performance.

Safety Interlock

When battery pack is connected to the motorcycle, if the battery management system detects a serious internal failure, one or both of two measures will be

taken to prevent damage to the battery pack:

Prohibited riding. If the battery pack state of charge (SOC) is 0, or if the battery management system detects some serious internal faults, the motorcycle will be prohibited from use until the problem is resolved.

Charging prohibited. If the battery management system detects some serious internal faults, it will prevent charging, even if the battery pack is connected to the charger and plugged into AC power until the problem is resolved.

Precautions for Ultra Bee Electric Motorcycle

Ultra Bee electric motorcycle has high voltage components. Take proper precautions when using it. The high voltage used in these components is dangerous and can result in burns, electric shocks and even serious personal injury.

For safety purposes always follow the instructions on the label attached to the motorcycle parts and do not touch or attempt to remove or replace any high voltage parts, wiring (marked by the orange outer tube) or connectors. In the event of an accident, do not touch any high voltage terminals or components connected to the wires. In case of a fire on the electric motorcycle, make sure your personal safety first and then uses Class D fire extinguisher to put out the fire. When the flame is out, use large quantity of water or a water-based fire extinguisher to cool it down. Do not forget to contact the fire rescue service

and inform them that an electric motorcycle with a lithium-ion battery is on fire.

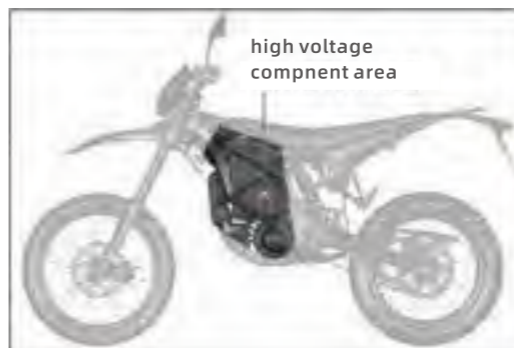

Warning

Ultra Bee electric motorcycle uses 74 Volts high voltage system. At the same time, the power system may be too hot to touch after use. Beware of high voltage and high temperatures and obey all the safety rules and regulations.

Serious Warning

The high voltage circuit system of the electric motorcycle is not allowed to be maintained by the customer. Removing and replacing high-voltage components, cables, or connectors may

Troubleshooting

result in severe burns or electric shocks, or even life-threatening injuries. **High-voltage cables are labeled orange for easy identification.**

System Warning Message

When a fault is detected, the orange fault indicator A on the top of the dashboard will light up, and the corresponding warning code will be displayed in the B area on the Dashboard LCD screen.

Note

When motorcycle had issue, the fault indicator will illuminate when in Total mileage mode; warning code will show when switch to Trip mileage mode.

Please refer to the table starting on the next page for possible causes and solutions.



WARNING CODE CHART

WARNING CODE	DESCRIPTION	SOLUTION
ER-000	Dashboard data communication protection	Check dashboard wire connection
ER-003	Over discharge protection (level 2)	Bike enter Low Power Mode, check if motor is in locked rotor condition
ER-004	REGEN overcurrent protection (level 2)	Lower REGEN setting
ER-008	Battery discharge MOS over temperature protection (level 2)	Stop using the bike and contact manufacturer or authorized dealer
ER-010	Battery charge MOS over temperature protection (level 2)	Stop charging and contact manufacturer or authorized dealer
ER-011	Startup self-diagnostic over temperature protection (level 1)	Turn OFF the key switch and back to ON again
ER-013	Battery cell temperature unbalance protection (level 2)	Stop using the bike and contact manufacturer or authorized dealer
ER-015	Battery pack insulation protection (level 2)	Stop using the bike and contact manufacturer or authorized dealer
ER-017	Battery cell volume unbalance protection (level 2)	Contact manufacturer or authorized dealer
ER-019	Battery cell low voltage protection (level 3)	Charging the battery pack
ER-022	Discharging over current protection (level 3)	Stop using the bike and contact manufacturer or authorized dealer
ER-024	Battery cell discharge over temperature protection (level 3)	Stop using the bike and wait until the temperature back to working condition
ER-025	Battery cell discharge low temperature protection (level 3)	Stop using the bike and wait until the temperature back to working condition
ER-030	BMS protection board 1 error	Contact manufacturer or authorized dealer
ER-031	BMS protection board 2 error	Contact manufacturer or authorized dealer
ER-037	Battery hall sensor error	Contact manufacturer or authorized dealer

11.4

ER-038	Battery voltage sensor error	Contact manufacturer or authorized dealer
ER-040	Battery all temperature sensor error	Contact manufacturer or authorized dealer
ER-041	Startup self-diagnostic temperature sensor error	Contact manufacturer or authorized dealer
ER-043	Battery discharge MOS error	Contact manufacturer or authorized dealer
ER-044	Battery charge MOS error	Contact manufacturer or authorized dealer
ER-100	MCU electron tube error	Contact manufacturer or authorized dealer
ER-101	MCU over current protection (level 1)	Bike enter Low Power Mode
ER-104	Motor position sensor error	Contact manufacturer or authorized dealer
ER-105	Motor locked rotor error	Check if motor is in locked rotor condition
ER-106	MCU sampling error	Contact manufacturer or authorized dealer
ER-107	MCU over temperature protection (level 2)	Stop using the bike and wait until the MCU temperature back to working condition
ER-108	Motor over temperature protection (level 2)	Stop using the bike and wait until the Motor temperature back to working condition
ER-109	Main power cable instant Low voltage protection	Check MCU main power cable
ER-110	Main power cable Low voltage protection (level 3)	Charging the battery pack
ER-111	Main power cable high voltage protection	Disable REGEN function
ER-113	Battery cell over/low temperature protection (level 3)	Stop using the bike and wait until the temperature back to working condition
ER-114	Throttle signal protection	Check if throttle cable is short circuited or unable back to idle position
ER-115	Throttle ground protection	Check if e-brake is short circuited

11.5

Troubleshooting

Troubleshooting

11.6

AL-116	Brake override triggered	Check if Brake override system is short circuited
AL-117	Side stand switch/motor stop switch triggered	Check if side stand switch is still down
AL-118	Tilt switch protection	Check tilt switch
ER-119	Main power cable Low power protection	Check bike communication cables, charge the battery pack
ER-127	Motor temperature sensor error	Contact manufacturer or authorized dealer
AL-128	REGEN disabled	Check battery temperature and battery voltage
ER-129	CAN communication error	Check all wire and cables
ER-130	Speed sensor error	Check if front and rear wheel speed sensor is well connected
ER-131	Main power cable instant High voltage protection	Disable REGEN function
ER-133	Key switch power loose protection	Check key switch and MCU cable connection
ER-134	MCU firmware malfunction protection	Turn OFF the key switch and back to ON again
ER-135	Battery cell high voltage difference protection	Contact manufacturer or authorized dealer
ER-136	High MOS discharging temperature MCU protection	Stop using the bike and wait until the temperature back to working condition
ER-137	Battery cell low voltage protection	Charging the battery pack and contact manufacturer or authorized dealer
ER-144	BMS discharging over current power limitation	low power mode (level 1)
ER-145	Battery cell high voltage difference power limitation	low power mode (level 2)
ER-146	High MOS discharging temperature power limitation	Stop using the bike and wait until the temperature back to working condition
AL-147	Battery cell low voltage power limitation	Charging the battery pack and contact manufacturer or authorized dealer

Troubleshooting

Faults	Possible cause	Action
Bike does not power on	Battery not plug into correct position	Check battery plug
	Battery SOC too low	Charging the battery
	Battery enters temperature protection	Wait until temperature back to working condition
	Main harness fuse melted	Check all wire and cables and replace fuse
	Key switch not properly engaged	Recheck key switch or replace new key switch
	DC converter error	Replace DC converter
	Battery malfunction	Contact manufacturer or authorized dealer
Bike powered on but not moving	Side stand switch protection	Lift Side stand up
	Brake override protection	Check Brake override system
	Tilt sensor was triggered but not reset	Switch off the key switch and turn on again after lift up the motorcycle
	Throttle not in idle position when motorcycle powered on	Check throttle position
	Battery low SOC protection	Charging the battery
	Motor temperature protection	Wait until the temperature back to working condition
	MCU temperature protection	
	Side stand switch error	Disconnect or replace side stand switch
	Brake override system error	Disconnect or replace Brake override switch
Tilt sensor error	Disconnect or replace tilt sensor	

11.7

Troubleshooting

Faults	Possible cause	Action
Bike powered on but battery SOC not display	Throttle error	Replace throttle
	MCU not plug in position	Check MCU plug connection
	Motor encoder not plug in position	Check motor encoder plug connection
	MCU or motor encoder error	Contact authorized dealer repair or replace MCU Contact authorized dealer repair or replace motor
Bike powered on but battery SOC not display	Coulombmeter not connect properly	Contact manufacturer or authorized dealer to repair or replace battery
	Coulombmeter error	Contact manufacturer or authorized dealer to repair or replace battery
Charger not working	Battery enters temperature protection	Wait until the temperature back to working condition
	charger not plug properly	Check power source and plug again
	Charger malfunction	Replace charger
	Battery malfunction	Contact manufacturer or authorized dealer
temperature back to working condition	Low battery SOC	Charge battery
	Battery temperature protection	Wait until the temperature back to working condition
	MCU or motor temperature protection	Wait until the temperature back to working condition
	Riding mode switch error	Replace riding mode switch
USB prot no power	USB not plug properly	Check USB connection and plug again
	USB converter error	Replace USB converter

Note: We will keep updating all the information above, please check latest version on our website

Warranty Information

CONDITION OF WARRANTY

Surron hereby warrants new Surron bike purchased from an Surron authorized dealer to be free from defect in materials and workmanship for the period of time stated herein, subject to certain limitations stated herein. This warranty applies only if the bike has been properly set-up and serviced for pre-delivery by an authorized Surron dealer. The warranty applies only if the motorcycle has been operated and maintained in accordance with the owner's manual or other Surron literature delivered with the bike. This warranty is void if the ONLINE OWNER'S REGISTRATION/ DEALER PRE-DELIVERY INSPECTION has not been completed in full and entered into Surron Distributor website within 7 days of purchase by the original selling dealer.

PERIOD OF WARRANTY FOR SURRON MOTORCYCLES

Street legal motorcycles ride on road and non-demonstrator motorcycles

Duration: 24 months from date of purchase or 16,000 kilometers, whichever comes first.

Limitations: The warranty can be transferred to subsequent owners within the stated warranty period.

Applies to: Ultra Bee R Version (Road), Ultra Bee T Version (Trail)

Off-road used motorcycles but not used in competition:

Duration: 6 months from date of purchase.

Limitations: This warranty is not transferable and applies to the original purchaser only.

Applies to: Ultra Bee T Version (Trail), Ultra Bee X Version (Offroad)

Competition motorcycles or any other Surron models used in competition:

Duration: 30 days from date of purchase.

Limitations: This warranty is not transferable and applies to the original purchaser only.

Applies to: Ultra Bee X Version (Offroad)

Any Surron motorcycle utilized commercially in connection with generating income and/or is commercially licensed or tagged (e.g., Rental, demonstrate, wholesale etc.,) during the warranty period will be covered for 30 days from the date of purchase.

Demonstrate motorcycle are Surron electric motorcycle that have been ridden by or used by Surron or a Surron authorized dealership's customers, members of the staff or press media, but have never been registered within the state, province or country.

The warranty period is effective on the date of purchase by the Original Purchaser and remains in effect only as stated above.

PARTS COVERED BY THE WARRANTY

Surron warrants to the customer that the motorcycle is defect-free both in terms of material and workmanship from the factory. Due to the battery chemistry, there is a normal, expected reduction in range/capacity that battery packs can yield over time and usage. Depending on use and storage conditions, battery packs will degrade during the duration of this warranty time. Surron will only repair or replace pursuant to this warranty term a battery pack that exhibits a nominal storage capacity reduction of greater than 20% of the published nominal capacity, as measured by Surron or a Surron authorized dealer/workshop.

Any part found to be defective during the motorcycles stated warranty period under proper use and normal operating conditions subject to the limitations of this warranty policy will be repaired or replaced free of charge. "Normal operating conditions" require routine care and maintenance of the Surron electric motorcycle and battery pack as described in the Owner's Manual.

WARRANTY LABOR COVERAGE

Labor to replace parts that are covered in the Surron warranty, which are found to be defective in material or workmanship, is no charge to the original purchaser. Warranty repairs must be done only with the authorization of Surron. The cost of parts and labor involved in any routine care and maintenance

Warranty Information

and/or the replacement of parts due to normal wear and tear, use, or deterioration, including but not limited to: tires, brake pads and rotors, drive belt, drive chain, fork seals, bearing, grips, foot pegs, and the seat etc.;

GENERAL EXCLUSIONS FROM WARRANTY

This warranty does not cover any failures resulting from, or caused by:

- 1.Lack of proper maintenance or contrary to the requirements described in the Owner's Manual.
- 2.Modification, alterations, and installation of parts that are not genuine Surron parts or supplied as original equipment.
- 3.Parts, components or battery pack damaged by use or operation under abnormal circumstances, damages due to accident, collision, abuse, neglect or exceeded use like competition level.
- 4.Modification, alterations, and installation of not genuine Surron or Surron authorized Power System like motor, gearbox, battery and MCU.
- 5.Normal wear components, including but not limited to, the following: tires, brake components, drive chain, drive belt, handle grips, all bearings, all seals, all transmission gear, suspension valving/seals, all sprockets, foot pegs and seat.
- 6.Damage, malfunctions, or performance problems caused by continued operation of the motorcycle after an error code shown or other warning indicates

Warranty Information

a mechanical or operational problem;

7.Any cosmetic concerns that arise as a result of environmental conditions, owner abuse, misuse, such as, but not limited to, using not suitable liquid etc., lack of routine care and maintenance, and/or improper use.

8.Damages or malfunctioned to the component and electric system due to owner installing non genuine Surron parts or replacement parts not approved by Surron.

9.Damages to the paint, coatings or corrosion of metal parts due to external influences such as stones, salt. Fading or painted or metal coated surfaces.

10.Damage, malfunctions, or performance problems caused by fire, collision, accident, or improper storage;

11. The tires installed on the Surron electric motorcycle. The original equipment tires are warranted separately by the tire manufacturer;

In addition, Surron warranty are only for end-user customers, not applicable to bike or accessories not imported or distributed by Surron or authorized by Surron.

OWNER RESPONSIBILITY //

1.Owner is responsible for to read and understand the Owner's manual, this warranty term, and all product warnings before operating your Surron electric motorcycle. Maintaining the Surron electric

motorcycle in accordance with the schedule printed in the Owner's manual.

2.Owner is responsible for the costs of maintenance to the motorcycle including service at scheduled intervals. Service work done by the owner will void the warranty. Perform all recommended and necessary routine care and maintenance and engage in proper use of your Surron electric motorcycle as detailed in the Owner's manual, failures caused directly by lack of maintenance or improper maintenance will void the warranty.

3.If warranty repairs are needed, they must be performed by an authorized Surron dealership with correct qualifications. The owner may be asked to provide the following documentation of proper maintenance: a maintenance record which displays the date of service and service work performed by an authorized dealer, copies of repair orders/ receipts.

4.The original registered owner as documented on the Surron motorcycle warranty registration form is responsible for conveying the Owner's Manual and all safety warnings, instructions, and Limited Warranty if the unit is sold, loaned, or otherwise transferred to another person.

5. Return the Surron motorcycle or parts to an authorized Surron dealer within ten (10) working days after discovery of any defective parts. Your Surron dealer should initially determine if the particular Surron component(s) in question are to be submitted to Surron for evaluation. All warranty work

must be performed by an authorized Surron dealer.

6.Owner is responsible for performing all recommended and necessary routine care and maintenance and engage in proper use of your Surron motorcycle and battery pack as detailed in the Owner's Manual including obtaining any firmware updates available at each service interval or in a timely basis following a notification that a new update is available of which must be completed by an authorized Surron dealer. Learn and obey all federal, state, and local laws governing the operations of a motorcycle, generally, and an electric motorcycle, specifically. When operating a Surron electric motorcycle, must wear proper safety equipment and clothing, including but not limited to helmet, eye protection, and appropriate boots at all times. Convey the Owner's Manual and all safety warnings, instructions, and Limited Warranty if the unit is sold, loaned, or otherwise transferred to another person.

7. Surron does not authorize any company or person to create a liability or any warranty obligation on its own behalf. Surron in its sole discretion will make the final disposition of any component(s) submitted for warranty evaluation. All parts and components returned to Surron, and replaced under this warranty shall become the property of Surron.

LIMITATIONS ON WARRANTY //

The limited warranty described in the Warranty information pages is the only warranty which applies

Warranty Information

to your motorcycle. Surron makes no other warranty or guarantee of any kind expressed or implied. No implied warranties of merchantability or fitness for a particular purpose or any purpose, is applicable to any product sold by Surron buyer and all other parties who contract with Surron, hereby specifically and knowledgeably waive any and all warranties, expressed or implied. This limited warranty does not cover any incidental or consequential damages, including loss of value of the motorcycle, lost profits or earnings, out-of-pocket expenses for substitute transportation etc., expenses associated with returning the covered product back to its owner, mechanic's travel time or communication charges, loss or damage to personal property, loss or time, or inconvenience. Surron has the right to continuously upgrade the design and electric system or improve not limited to the motorcycle, power system or battery pack. Some countries do not allow limitations on how long an implied warranty lasts, so the above limitations may not apply to you. also excluded from this warranty are any incidental or consequential damages including loss of use. Some countries do not allow the exclusion or limitation of incidental or consequential damages, so the above exclusion may not apply to you. This warranty gives you specific legal rights, and you may also have other rights, which vary, from country to country. The contents stated herein are subject to change without notice.

Warranty Information

HOW TO OBTAIN WARRANTY SERVICE //

To receive any type of warranty service, take your Surron motorcycle and warranty registration proof to any authorized Surron dealer during normal service hours. If you believe that your vehicle has a defect which could cause a crash or could cause injury or death, you should immediately inform Surron or your Surron authorized dealer. If you fail or does not meet the conditions and scope of the warranty terms, we can still provide repair services upon your request with certain charge. If you are unable to get satisfactory warranty service at a Surron dealer, or you are dissatisfied with a warranty decision, please write e-mail to the following address:

service@qiulongtech.com

We will need the following information in order to assist you:

- Your name, address, and phone number
- Product model and vehicle identification number (VIN number)
- Date of purchase-Dealer name and address-Nature of problem

Note

We will complete the warranty work as soon as possible, but not responsible for delays in work caused by factors beyond our control. The aforementioned factors include but are not limited to: shortage of spare parts, delay in transportation, force majeure, etc.

Reporting Safety Defects //

United States

If you believe that your vehicle has a defect which could cause a crash or could cause injury or death, you should immediately inform the National Highway Traffic Safety Administration (NHTSA) in addition to notifying Surron. If NHTSA receives similar complaints, it may open an investigation, and if it finds that a safety defect exists in a group of vehicles, it may order a recall and remedy campaign. However, NHTSA cannot become involved in individual problems between you, your dealer, or Surron. To contact NHTSA, you may call the Vehicle Safety Hotline toll-free at:

1-888-327-4236 (TTY: 1-800-424-9153); go to

<http://www.safercar.gov>

or write to:

Administrator

National Highway Traffic Safety

Warranty Information

1200 New Jersey Avenue SE

Washington, DC 20590

You can also obtain other information about motor vehicle safety from:

<http://www.safercar.gov>

Canada

If you believe that your vehicle has a defect which could cause a crash or could cause injury or death, you should immediately inform Transport Canada, in addition to notifying Surron.

To contact Transport Canada, call their toll-free number:

+1-800-333-0510

United Kingdom, Europe, and Global Markets

If you believe that your vehicle has a defect which could cause a crash or could cause injury or death, you should immediately inform your Surron authorized dealer. If you are unable to resolve the issue with your Surron authorized dealer you can contact Surron directly on +86-23-6890-5603, or through our website at:

<http://www.sur-ron.com>

Warranty Information

12.5

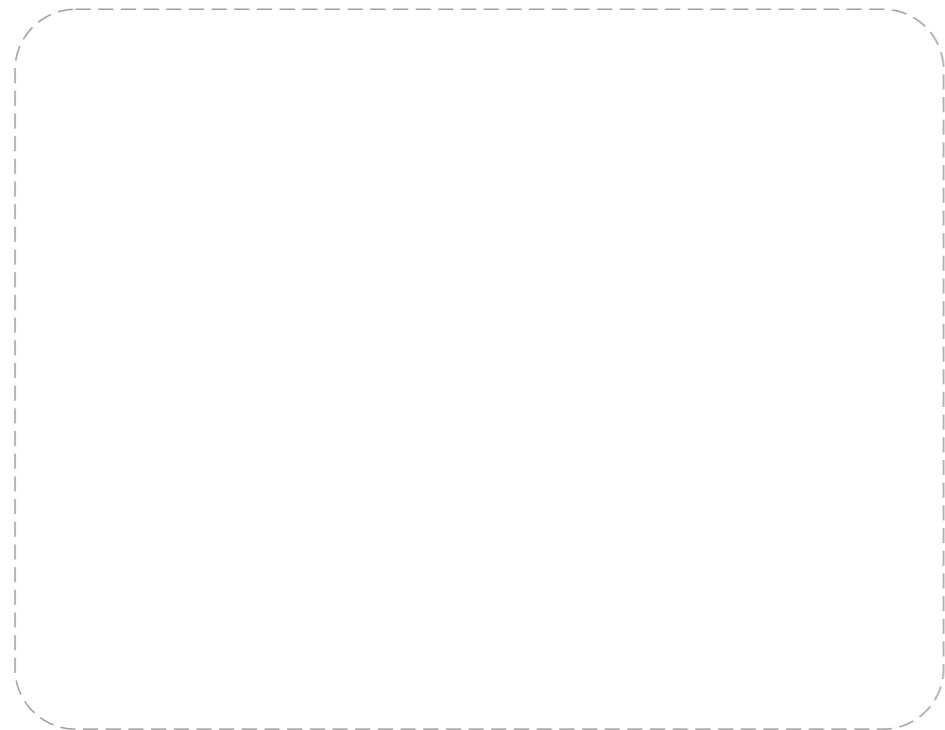

-FETCH LIGHT-飞起来-

Warranty Information

12.6

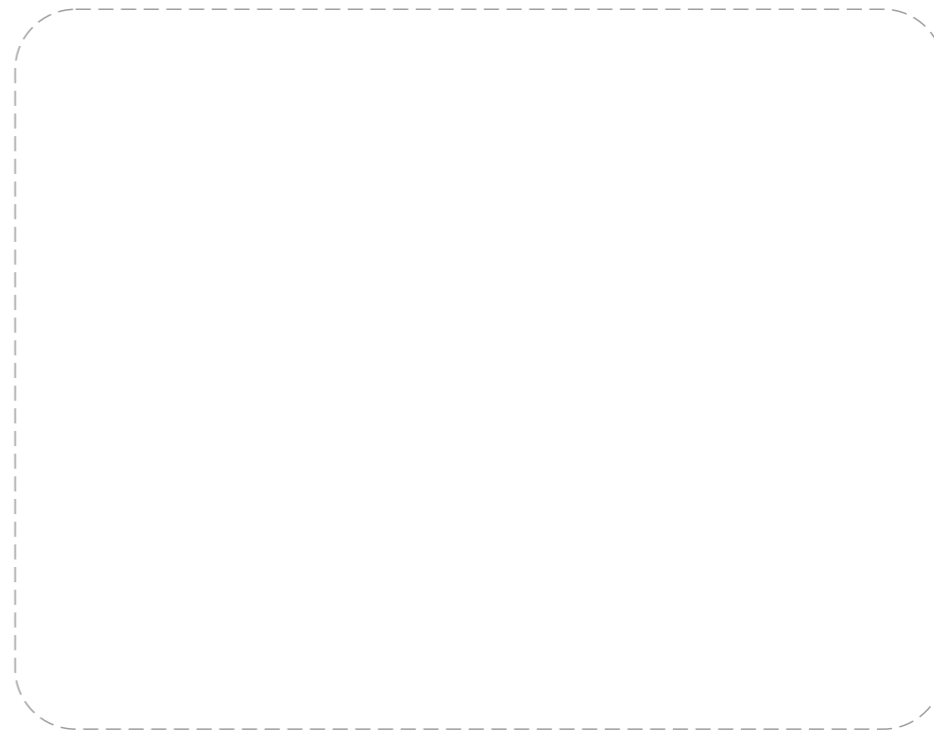

-FETCH LIGHT-飞起来-

Warranty Information

12.7

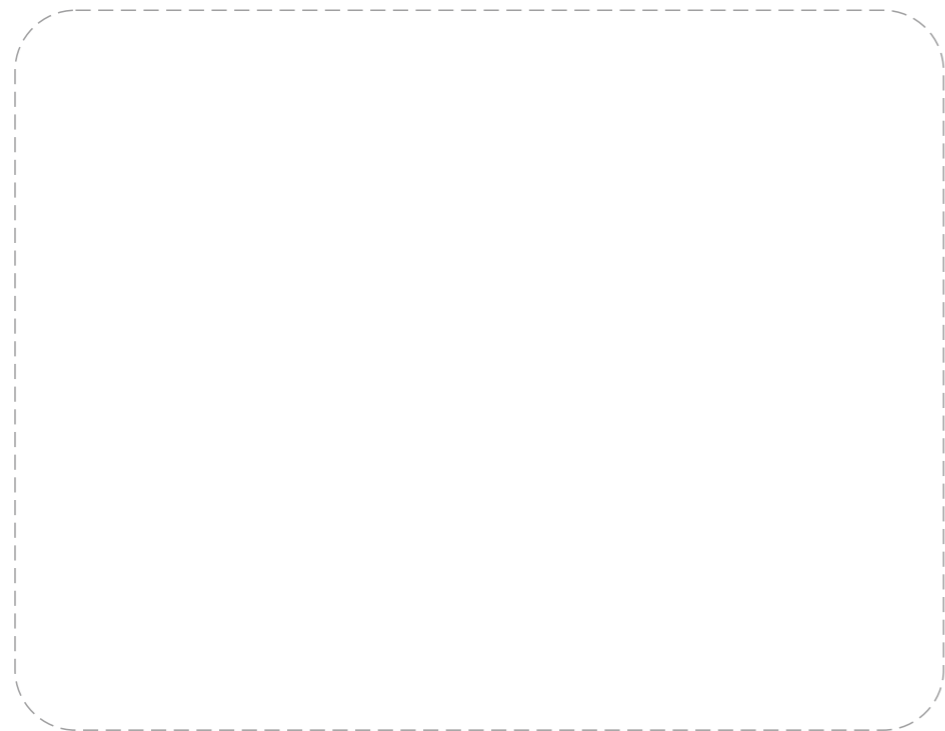

-FETCH LIGHT-飞起来-

Warranty Information

12.8

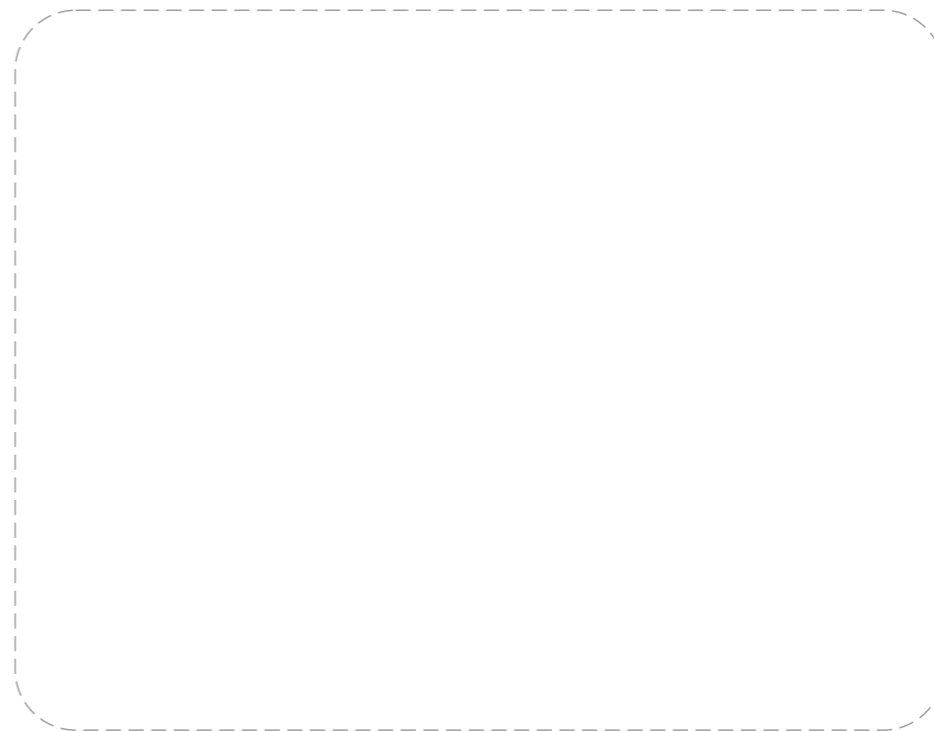

-FETCH LIGHT-飞起来-

After you have had your motorcycle serviced, please make sure that the appropriate maintenance record has been completed. Use the space "Remark" to record issues you want to remind yourself about or mention at the next service.

100KM

Odometer reading		Performed by		Date	
Maintenance Record Sheet					
Remark					

13.1

500KM

Odometer reading		Performed by		Date	
Maintenance Record Sheet					
Remark					

13.2

1000KM

Odometer reading		Performed by		Date	
Maintenance Record Sheet					
Remark					

13.3

2000KM

Odometer reading		Performed by		Date	
Maintenance Record Sheet					
Remark					

13.4

5000KM

Odometer reading		Performed by		Date	
Maintenance Record Sheet					
Remark					

13.5

10000KM|12months

Odometer reading		Performed by		Date	
Maintenance Record Sheet					
Remark					

13.6

After-sales services record sheet					
	Odometer reading	Warranty item	Performed by	Date	Remark
1					
2					
3					
4					
5					

13.7

After-sales services record sheet					
	Odometer reading	Warranty item	Performed by	Date	Remark
6					
7					
8					
9					
10					

13.8

车型参数对比

车型配置	ULTRA BEE X (Offroad)	ULTRA BEE T (Trail)
VEHICLE MODEL	QL6000DY-A	QL6000DY
Dimension	2060mm×880mm×1178mm	2010mm×880mm×1178mm
Ground clearance	318mm	318mm
Seat height	910mm	910mm
Dry/Curb weight	85kg	89kg
Carrying capacity	100kg	150kg
Front tire	80 / 100-19 offroad tire	80 / 100-19 offroad tire
Rear tire	80 / 100-19 offroad tire	80 / 100-19 offroad tire
Assistance functions	ASR + BERS	ASR + BERS
Wheel base	1380mm	
Front fork travel	240mm	
Rear shock/wheel travel	85/240mm	
Power system	Mid-drive BLDC motor + FOC sine wave controller	
Rated power	6KW	
Maximum power	12.5KW	
Maximum torque	440N.m	
Top speed	90km/h	
Range	104Km (@50km/h)	
Battery Type	74V/55Ah lithium-ion removable battery pack	
Charge time	4.5h	
Frame design	Aluminum forged frame	
Riding mode	Eco / Daily/ Sport mode + Reverse Mode	

车型参数对比

车型配置	ULTRA BEE R (Road)
VEHICLE MODEL	QL6000DY-B
Dimension	2060mm×880mm×1178mm
Ground clearance	318mm
Seat height	910mm
Dry/Curb weight	93kg
Carrying capacity	150kg
Front tire	90 / 90-19 all terrain tire
Rear tire	120 / 80-18 all terrain tire
Assistance functions	ASR + BERS+ABS
Wheel base	1380mm
Front fork travel	240mm
Rear shock/wheel travel	85/240mm
Power system	Mid-drive BLDC motor + FOC sine wave controller
Rated power	6KW
Maximum power	12.5KW
Maximum torque	440N.m
Top speed	90km/h
Range	104Km (@50km/h)
Battery Type	74V/55Ah lithium-ion removable battery pack
Charge time	4.5h
Frame design	Aluminum forged frame
Riding mode	Eco / Daily/ Sport mode + Reverse Mode

Changes or modifications not expressly approved by the party responsible for compliance could void the user's authority to operate the equipment.

Note

This equipment has been tested and found to comply with the limits for a Class B digital device, pursuant to Part 15 of the FCC Rules. These limits are designed to provide reasonable protection against harmful interference in a residential installation. This equipment generates, uses and can radiate radio frequency energy and, if not installed and used in accordance with the instructions, may cause harmful interference to radio communications. However, there is no guarantee that interference will not occur in a particular installation. If this equipment does cause harmful interference to radio or television reception, which can be determined by turning the equipment off and on, the user is encouraged to try to correct the interference by one or more of the following measures:

- 1.Reorient or relocate the receiving antenna.
- 2.Increase the separation between the equipment and receiver.
- 3.Connect the equipment into an outlet on a circuit different from that to which the receiver is connected.

- 4.Consult the dealer or an experienced radio/TV technician for help.

You and the Environment

Owning and riding a motorcycle can be enjoyable, but you must do your part to protect nature. When you show respect for the land, wildlife, and other people, you also help preserve the sport of off-road riding.

Following are tips on how you can be an environmentally responsible motorcycle owner.

- 1.Choose sensible cleaners. Use a biodegradable detergent when you wash your Ultra Bee. Avoid aerosol spray cleaners that contain chlorofluorocarbons which damage the atmosphere's protective ozone layer. Don't throw cleaning solvents away; see the following guidelines for proper disposal.
- 2.Recycle Wastes. It's illegal and thoughtless to put used engine oil in the trash, down a drain, or on the ground. Use coolant, and cleaning solvents contain poisons that can hurt refuse workers and contaminate our drinking water lakes, rivers, and oceans.

- 3.Put toxic wastes in separate sealed containers and take them to a recycling center. Call your local or state office of public works or environmental services to find a recycling center in your area and get instructions on how to dispose of non-recyclable wastes. Improper disposal of drained fluids is harmful to the environment.